

SECTION 1. INTRODUCTION TO THE PC-1100/1200

1-1. GENERAL DESCRIPTION

The Westinghouse PC-1100/1200 programmable controllers are microprocessor-based controllers designed for a wide range of small- to medium-sized industrial control applications. The rugged construction, simple programming and powerful control capabilities of the PC-1100/1200 are backed by Westinghouse with a comprehensive support program to maximize the performance of the system.

This document describes the installation, programming, and operation of the PC-1100/1200 controllers.

Westinghouse is dedicated to meeting industry's control requirements with its programmable controller products. Contact your Westinghouse Sales Representative for information about the latest product developments. To request information or comment on the Westinghouse programmable controllers and their application, use the post-paid card provided at the back of this manual.

1-2. PC-1100/1200 Family of Controllers

Westinghouse offers a full line of controllers to meet a variety of needs. This volume describes the PC-1100/1200 family of controllers, which includes the PC-1100, PC-1200, and PC-1250.

Several versions of the PC-1100, PC-1200, and PC-1250 are available. They provide a range of memory and I/O capabilities, appropriate for small to medium sized applications. These Westinghouse controllers all use the same base set of special functions, providing compatibility for networking or program transfer.

The primary differences among these controllers are listed below:

- **Memory size** ranges from 0.5 to 16K.
- **I/O Capacity** ranges from 128 discrete/ 16 register to 512 discrete/ 256 register.
- **Dual I/O bus** in the PC-1250 provides expanded I/O capacity with rapid updating.
- **Expanded special function sets** are provided by several PC-1100, -1200, and -1250 models.

Table 1-1 gives a complete listing of the available PC-1100 models. Table 1-2 describes the PC-1200 and -1250 models. For details on the special functions supported by each model, refer to Section 5.

TABLE 1-1. PC-1100 MODELS

Catalog Numbers	Memory Size	Total I/O Capacity ¹	
		Discrete	Register
PC-1100-1011, -1021, -2011, -2021,	0.5K	128	16
PC-1100-1012, -1022, -1052, -2012, -2022, -2052	1.5K	128	16
PC-1100-1013, -1023, -1033, -2013, -2023, -2033	2.5K	128	16
PC-1100-1014, -1024, -1054, -2014, -2024, -2054	3.5K	128	16

¹ 'Total I/O capacity' refers to combined number of inputs and outputs. For example, 64 discrete inputs plus 64 discrete outputs equals 128 total discrete I/O.

TABLE 1-2. PC-1200 AND -1250 MODELS

Catalog Number	Executive Number ¹	Memory Size	Total I/O Capacity ²	
			Discrete	Register
PC-1200-1020	1207	2K	128	64
PC-1200-1040	1206	2K	128 256	64 128
PC-1200-1041	1205	4K	256	128
PC-1200-1042	1204	8K	256	128
PC-1200-1043	1203	16K	256	128
PC-1250-1042	1202	8K	512	256
PC-1250-1043	1201	16K	512	256

¹ The 'Executive Number' is displayed on the program loader status screen.

² 'Total I/O capacity' refers to combined number of inputs and outputs. For example, 64 discrete inputs plus 64 discrete outputs equals 128 total discrete I/O.

Note

Throughout this volume, the term 'PC-1200' is used to refer to the PC-1200 or -1250. The term 'PC-1250' is used only when discussing differences between the -1200 and -1250, such as the dual I/O bus.

1-3. SCOPE

This manual consists of the following sections:

- Section 1. Introduction: Provides an overview of the scope and content of this document, provides unpacking and storage instructions, and lists other reference documents.
- Section 2. System Overview: Describes the PC-1100/1200 control system components and performance.
- Section 3. Installation and Start-up: Provides installation and start-up procedures.
- Section 4. Programming Approach: Describes the programming approach used with the PC-1100/1200 controllers.
- Section 5. Special Functions: Provides a description of each special function (presented in alphabetical order for easy reference).
- Section 6. Troubleshooting: Describes the PC-1100/1200 fault indications, and provides a suggested procedure for troubleshooting the controllers.

1-4. UNPACKING PROCEDURES

Westinghouse programmable controllers and associated hardware are extensively tested and carefully packed prior to shipment. This equipment, when delivered, should be inspected for visible damage. It should also be inventoried to verify that both the quantities and types of components ordered have been delivered. The equipment should also be tested to ensure that it is operational. (See Section 3 for instructions on handling this equipment upon delivery.)

NOTICE

ANY CLAIM FOR DAMAGES SHOULD BE FILED WITH THE CARRIER OR HIS AGENT. ALSO, NOTIFY THE FACTORY SO THAT CORRECTIVE ACTION CAN BE TAKEN AT THE EARLIEST POSSIBLE TIME.

1-5. STORAGE

If the equipment is not used immediately upon arrival, place it in the original shipping cartons and store in a dry protected location with the following characteristics:

Storage temperatures: -40°C to +60°C (-40°F to ¹⁴⁰~~149~~°F)

Relative humidity: 0 to 95% non-condensing.

1-6. REFERENCE MANUALS

The information in this manual applies only to PC-1100 and -1200 programmable controllers.

For additional information on the available program loaders, refer to the following documents:

- "CRT Programming Manual" (NLAM-B56)
- "Mini Loader Programming Manual" (NLAM-B60)
- "PC Communications Manual" (NLAM-B58)
- "Advanced Program Loader Programming Manual" (NLAM-B816)
- "Offline Programming Utilities" (for NLSW-784 or NLSW-783U)

For additional information on the available I/O modules and other components, refer to the documents listed in Table 1-3.

TABLE 1-3. I/O MODULES AND OTHER COMPONENTS

Component	Catalog No.	Instruction Leaflet No.
8-point Input Modules 12-48, 120, 240 VAC/DC	NL-1003, -1005, -1006	IL-15675
8-point Output Modules 120, 24, 240 VAC	NL-1020, -1022, -1023	IL-15680
8-point Output Modules 5, 24, 48 VDC	NL-1025, -1026, -1027	IL-15676
16-point Input Module 24 VDC	NL-1030F	--
16-point Output Module 24 VDC	NL-1060F	--
8-bit A/D Input Modules 0-5 V (4- or 8- channel)	NL-1045, -1046	IL-15683
8-bit A/D Input Modules 4-20 mA (4- or 8- channel)	NL-1049, -1050	IL-15684
8-bit D/A Module (4-channel)	NL-1057	IL-18457
12-bit A/D Input Module	NL-1052	--

TABLE 1-3. I/O MODULES AND OTHER COMPONENTS, CONT'D

Component	Catalog No.	Instruction Leaflet No.
Register Input Module	NL-1017	IL-15681
Register Output Module	NL-1018	IL-15680
Relay Output Modules	NL-1015, -1016	IL-15678
Watchdog Module	NL-1080	IL-18456
PC-1100/1200 Main Racks	NLR-1004, -1008, -1012, -1016	IL-15677
Expansion Racks	NLRE-1009, -1011, -1011B, -1013, -1017	IL-15693
Expansion Power Supply	NLE-1070	--
Communication Expansion Module	NL-1075	IL-15753
Rack Bus Expansion Module	NL-1076	IL-15693
Dual Bus Expansion Module	NL-1077	--
Memory Safe Module	NLMS-1100 A, B, C	IL-15694



SECTION 2. SYSTEM OVERVIEW

2-1. BASIC CONTROL SYSTEM

Control systems basically consist of three sections, as shown in Figure 2-1.

- An INPUT SECTION, which gathers the information required to keep track of the real-world operations being controlled.
- A LOGIC SECTION, which processes the information acquired by the input section, and which determines which output function should be activated.
- An OUTPUT SECTION, which provides control by activating the appropriate devices within the real-world operations being controlled.

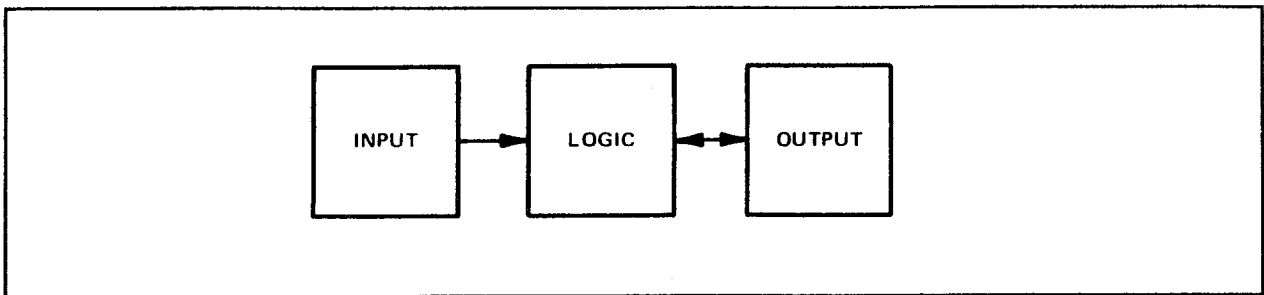

Figure 2-1. Three Sections of Any Control System

The three basic sections of a relay control system are symbolically shown in Figure 2-2. In relay control applications, the input section consists of input devices, such as pushbuttons, limit switches and photocells. The logic section is composed of control relays wired together to produce the desired real-world operations. The output section contains output devices, such as motor starters, solenoids and indicator lights.

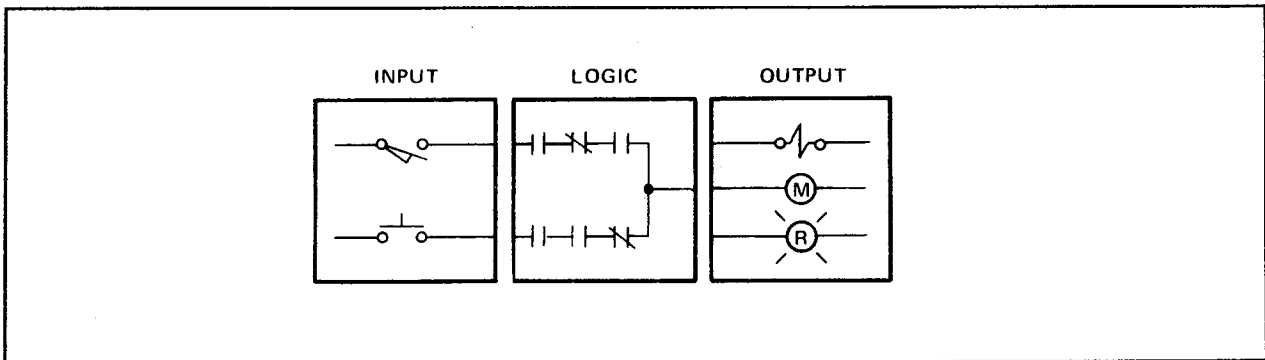

Figure 2-2. Relay-type Control System

Figure 2-3 shows these three sections as they are represented for a programmable control system. The primary difference between the two types of systems is that the control relay logic is replaced by a solid-state processor and memory configuration. Through programming, the processor and memory digitally process all the data for system operation. The processor's memory is programmed to duplicate the require operating instructions of the control relay circuits.

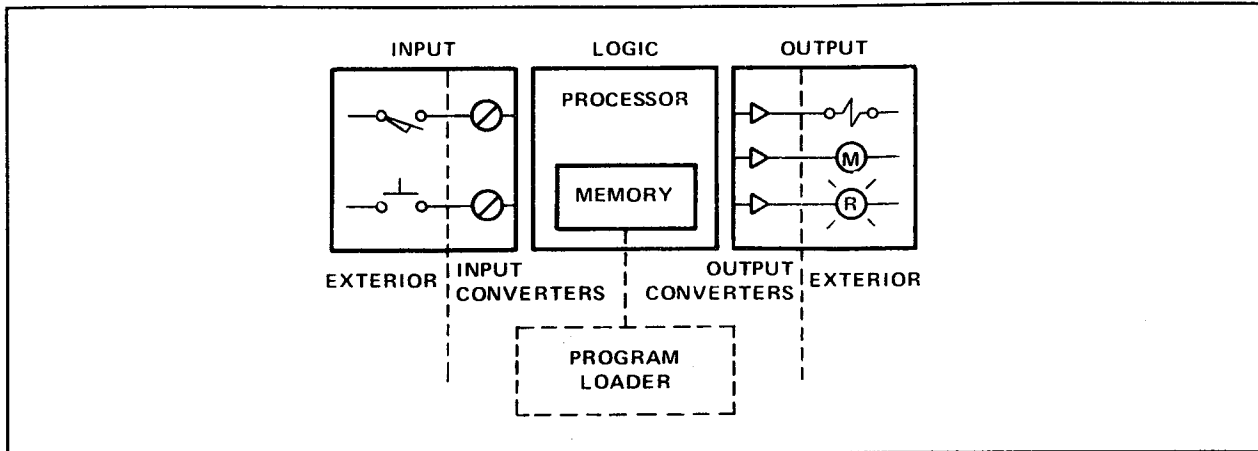

Figure 2-3. Three Sections of a Programmable Controller

The input section contains the same input devices that are found in the relay control system. However, the process input signals produced by these input devices are converted into low-level DC logic voltages suitable for solid-state controller operations. The output section in a programmable control system converts the low-level logic signals from the processor into the voltage levels required to operate output devices. The output devices are the same as those utilized in relay control systems.

An advantage of this type of control is the ease with which the system's control logic can be modified into a variety of operating configurations by means of a program loader.

2-2. PC-1100/1200 PROGRAMMABLE CONTROL SYSTEM

A simplified block diagram of the basic PC-1100 or PC-1200 programmable controller system is shown in Figure 2-4. The control system contains a rack-mounted controller (PC-1100 or -1200); rack-mounted input and output modules; and a program loader. Other peripherals are also available (as described in Paragraph 2-17). A description of each of these system components follows.

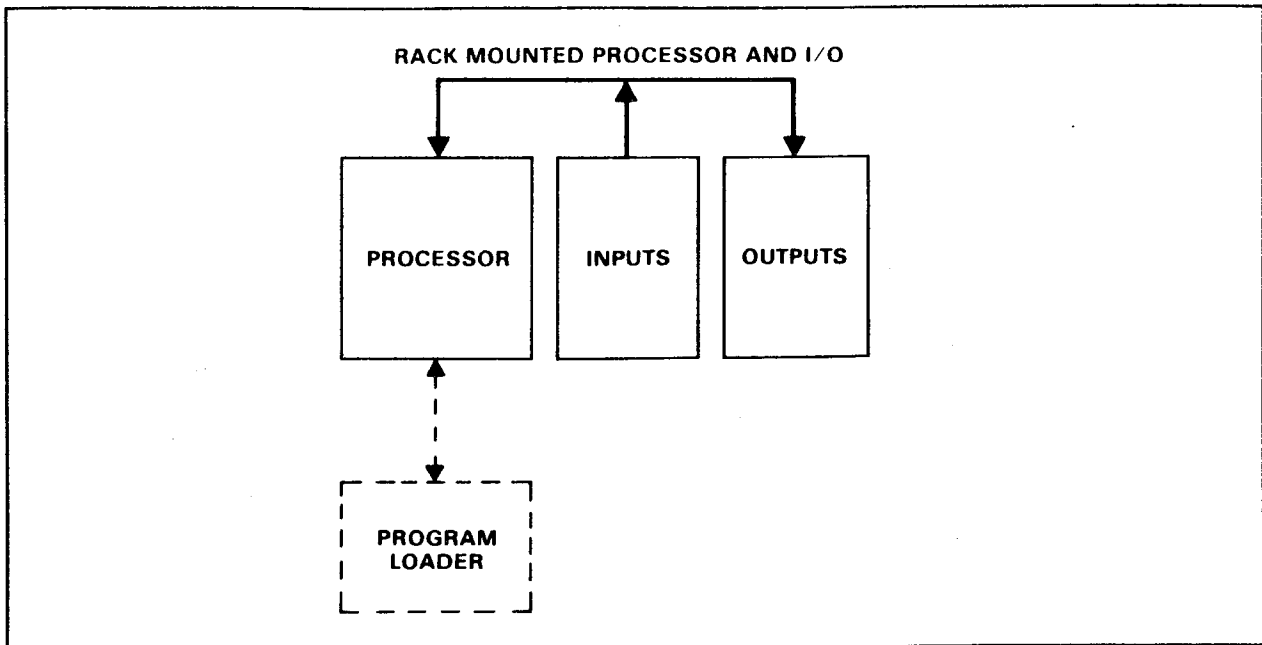

Figure 2-4. Basic PC-1100/1200 System

2-3. CONTROLLER

The PC-1100 or PC-1200 programmable controller is the center of the programmable control system. The controller coordinates the operation of the entire control system. It monitors inputs; scans and solves logic; and controls the state of outputs. A simplified block diagram for the PC-1100/1200 controller is shown in Figure 2-5.

The PC-1100/1200 controller houses a variety of subsections which provide individual functions for system process control.

- I/O image memory: Stores the current input/output status information.
- User memory: Stores ladder diagram instructions and holding register information.
- Processing circuitry: Uses the current input/output status information stored in the I/O image memory to execute the ladder diagram instructions stored in the user memory.
- Communications circuitry: Provides the interface between the controller and the I/O system, as well as the interface between the controller and the program loader (or computer).

A description of each controller subsection (shown in the block diagram) follows.

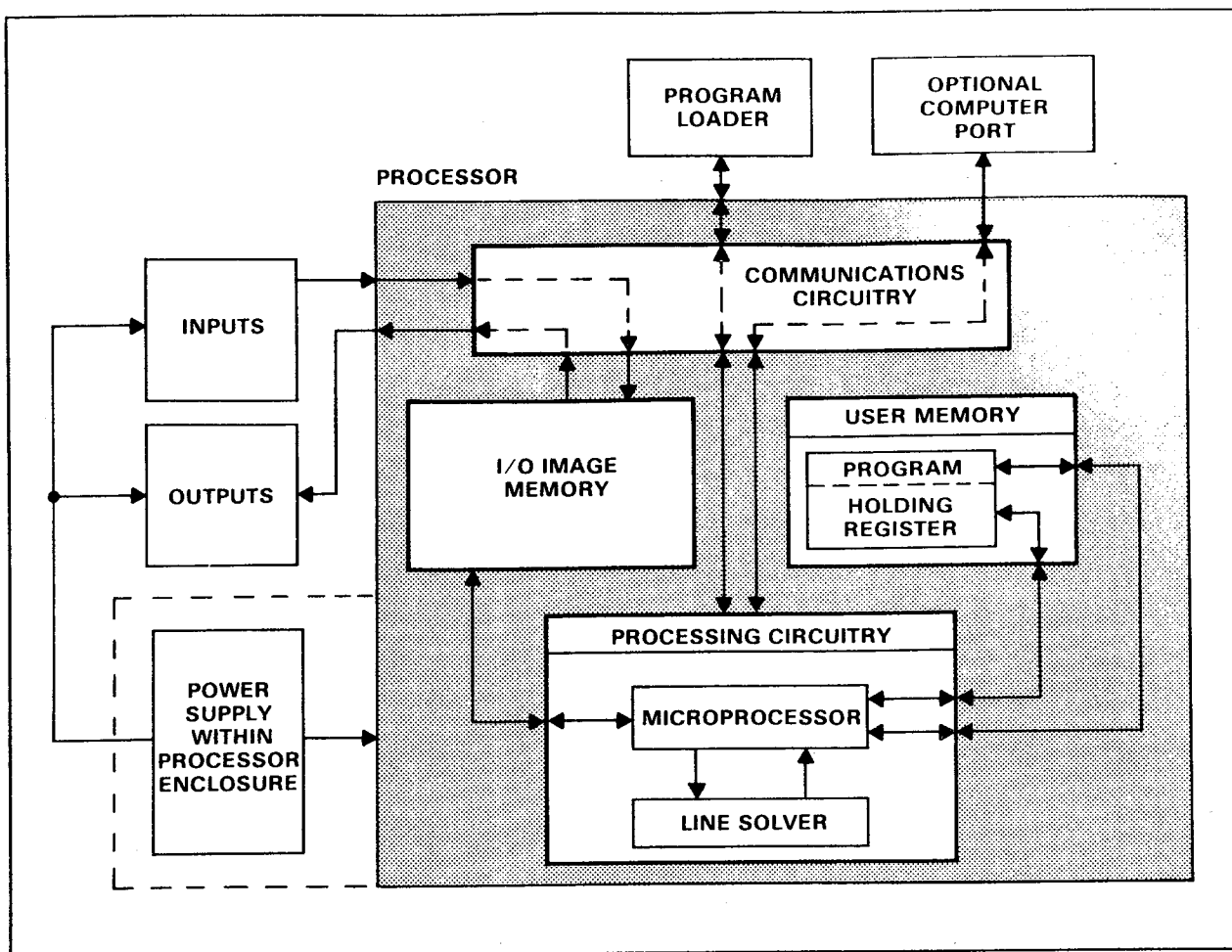

Figure 2-5. Simplified PC-1100/1200 Controller Block Diagram

2-4. Memory

The PC-1100/1200 user memory contains the ladder diagram instructions and serves as the storage location for holding register values required by the program. A separate memory area is provided for the I/O image table. Each of these is described below.

User Memory

The capacity of the PC-1100/1200 programmable controller is proportional to the size of the user memory. One 16-bit word of memory is used for each contact and for each coil. Nodes, branches and unused contacts do not require any words of memory, thereby increasing memory utilization over conventional memory schemes.

The PC-1100 programmable controller is available in four operational memory sizes: 512, 1536, 2560 and 3584 words of RAM. Each PC-1100 memory configuration supports 64 discrete inputs, 64 discrete outputs, 8 register inputs, and 8 register outputs. Additionally, the PC-1100 supports 64 or 192 internal logic coils (depending on software level). Up to 1792 holding registers are supported, depending on memory size.

The PC-1200 is available with 2K, 4K, 8K, or 16K words of RAM. The PC-1200-1020 and -1040 support 64 discrete inputs, 64 discrete outputs, 32 register inputs, 32 register outputs, and 960 internal logic coils. The PC-1200-1041, 1042, and 1043 support 128 discrete inputs, 128 discrete outputs, 64 register inputs, 64 register outputs, and 896 internal logic coils. Up to 1792 holding registers are supported in all versions of the PC-1200.

The PC-1250 is available with 8K or 16K words of RAM. The PC-1250 supports 256 discrete inputs, 256 discrete outputs, 128 register inputs, 128 register outputs, and 768 internal logic coils. Up to 1792 holding registers are supported.

A backup battery system maintains the program in user memory in the event of AC power loss. For the PC-1100, the battery backup consists of 3 Type AA alkaline cells. It is capable of maintaining memory for a minimum of 3 months. For the PC-1200 and PC-1250, a single Type AA lithium battery is used, providing a minimum of 1 year of backup.

I/O Image Memory

The I/O image memory stores the input and output values that are used during each scan of the ladder diagram. The output values in the I/O image table are updated as each rung of the ladder is completed. The sequence in which the I/O image table and the actual outputs are updated is described in Paragraph 2-6 below.

2-5. Processing Circuitry

The PC-1100/1200 programmable controller processing circuitry contains microprocessor and line-solver logic which provide the vehicle for program processing. Circuits are programmed into the controller from a reference ladder diagram by means of relay symbology.

This processing circuitry sets the output circuit states based on programming information contained in the memories. The state (open or closed) of the input contacts and CR contacts is stored in the I/O image memory. The states of the stored contacts involved in each programmed circuit are selected according to reference labels (addressing) of the program stored in user memory. Each circuit is constructed, contact-by-contact, under program control. The selected contact states are used to determine whether the programmed circuit is conducting.

If the programmed rung controls a coil, the state of the coil in the I/O image memory is determined from new state of the rung. The new state of this coil's contacts (and output circuit, if any) is available to the controller as it scans subsequent rungs.

If the programmed rung controls a special function, the special function sequence is activated when the circuit(s) change to the proper state. The special function sequence changes the associated coil state and register values in the controller's memories. These new states are used when the controller scans subsequent rungs.

On-Line Programming and Last Valid State

The PC-1100/1200 programmable controller offers an on-line programming option which is selectable by means of a DIP switch located behind the front panel of the controller. This option enables the user to enter, delete and alter the reference ladder diagram while the controller is executing a program, without disruption of control operations.

Units shipped from the factory are set for off-line programming. An associated resistor (R2 on the PC-1100 or R70 on the PC-1200) may be removed to permanently set the controller for off-line programming only.

Another switch is used for last valid state selection. This determines whether to leave outputs off or in their last known state in the event of a controller malfunction (other than a power loss). This switch is shipped from the factory in the ALL OFF position. Therefore, in the event of a fault, all outputs turn OFF. At the user's option, this switch can be changed to the LAST VALID STATE (LVS) position so all outputs remain in their last valid state when the controller enters a fault condition.

A label on the inside cover of the PC-1100 or -1200 unit describes the DIP switch settings. For additional information, refer to Paragraph 3-17.

2-6. I/O Servicing

At the beginning of each controller scan, the input circuit states are read and transferred into the I/O image memory.

As each rung of the ladder is solved, the stored circuit states are read from the I/O image table. When the rung is completed, the newly determined coil and output register states are written into the I/O image table.

At the end of each controller scan, the controller transfers the stored output states from the I/O image memory to the output circuits.

Power-up Sequence

On power-up, all outputs are held disabled while hardware initialization and self-tests are performed. If the keyswitch is in the RUN position, the controller performs an initial power-up scan to set all discrete output states to logic 0 (OFF) and to update the inputs to the I/O image memory. The controller then performs a logic scan (to update the output image memory) while maintaining all outputs disabled (OFF). Following this scan, the front panel RUN LED lights. At this point, the outputs are enabled according to the logic scan, and normal controller operation begins, scanning memory and controlling outputs.

If the keyswitch is in the STOP position when the controller is powered-up, the controller enters directly into the program mode.

When the controller senses a power-down, all outputs are disabled. On power-down detection, the controller calculates and stores checksums which are used to verify memory during a subsequent power-up.

Note

A forced discrete I/O point retains its forced state, and an output register retains its previous state.

2-7. Power Supplies

The DC power required to operate the controller and main rack I/O cards is provided by the controller's internal power supply. The available power output capacity of the internal power supply is 2 A for the Standard PC-1100 and 1.7 A for the Advanced PC-1100. For the PC-1200, the available power output capacity is 2.5 A.

To provide additional I/O power for an expansion rack, an expansion power supply may be required. Several of the expansion racks (NLRE-1011B, NLRE-1013, and NLRE-1017) require the rack-mounted NLE-1070 expansion power supply. The NLE-1070 provides 5 A of power for the I/O modules.

When designing a system, the user must pay attention to the total power consumption of all the modules, to avoid exceeding the power supplies' capabilities. Refer to Paragraph 2-16 for additional information regarding module power requirements and the optional external power supply.

2-8. Controls and Indicators

The PC-1100 and -1200 programmable controller front panels' controls and indicators are shown in Figure 2-6. A description of the front panel controls and indicators is given in Table 2-1.

There are two controller keyswitch positions:

- **RUN:** With the keyswitch in this position, the controller scans memory and control outputs. Also, the program loader may be used to monitor and force I/O and to make register data changes.
- **STOP:** With the keyswitch in this position, the controller stops scanning and disables all outputs. The program loader can alter circuit connections or delete lines when the keyswitch is in this position.

Note

If the On Line Programming (OLP) switch is set for On Line, program alterations can be made with the keyswitch in the RUN or STOP position.

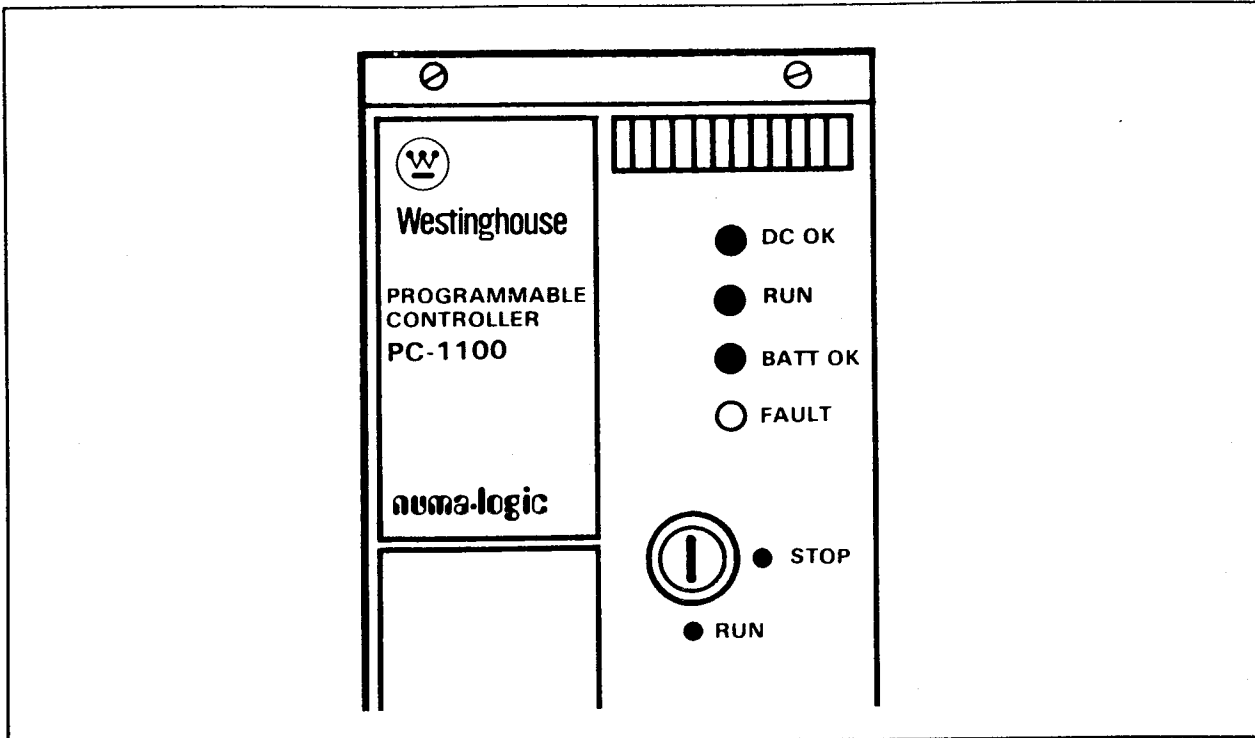

Figure 2-6. PC-1100/1200 Controls and Indicators

TABLE 2-1. PANEL CONTROLS AND INDICATORS

Type	Label	Description
Panel Controls (Keyswitch)	RUN	This switch position prevents unauthorized programming. It permits controller to operate normally. Lines cannot be added, deleted or changed unless "on-line" programming is selected.
	STOP	This switch position enables controller programming; however, controller and I/O operation operation is inhibited.
LED Indicators	RUN	Indicates that the controller is scanning the program and controlling outputs. The outputs are disabled when LED is OFF (not lit).
	FAULT	Indicates that a controller or power supply failure has been detected.
	POWER OK	Indicates that the internal power supply voltage are present and within limits.
	BATTERY OK	Indicates that the battery back-up is operational and will maintain RAM memory. If extinguished, indicates that battery is capable of supporting controller for less than one week.

2-9. Controller Connections

The input AC power and voltage-select connections are made to 300 V dead-front pressure terminals located on the front face of the PC-1100/1200. (See Figure 2-7.)

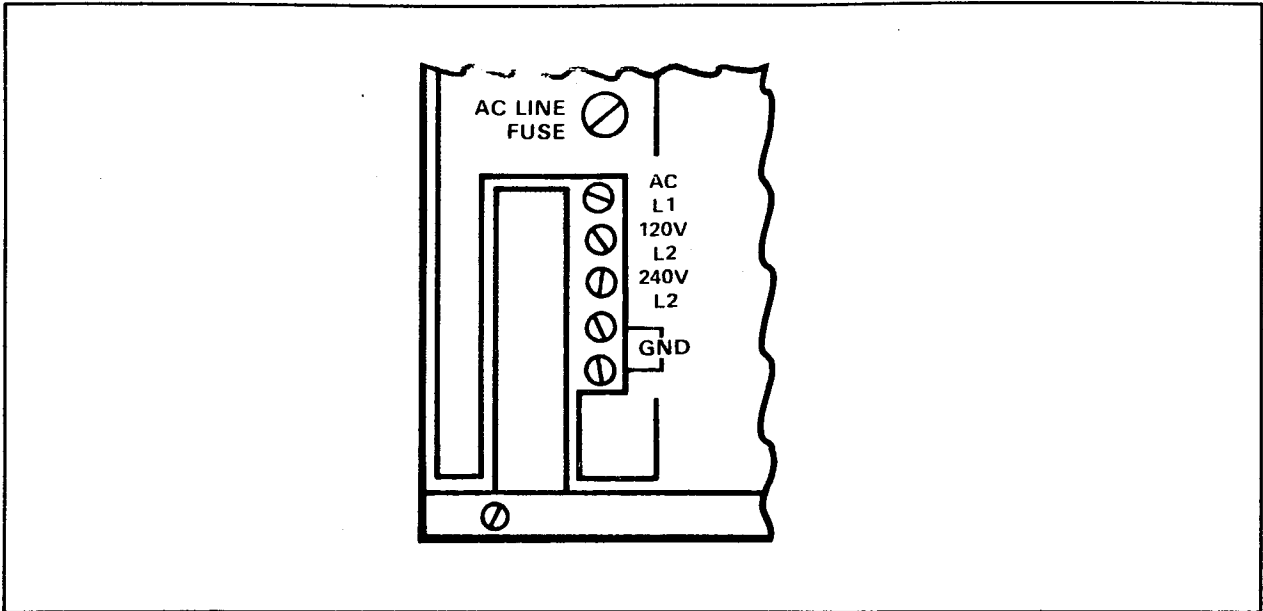

Figure 2-7. PC-1100/1200 Connector Identification

Program loader connection to the PC-1100/1200 controller is made on the D-type connector on the front face by means of the program loader communications cable. (See Figure 2-8.) The PC-1100 connector uses slide lock mounting hardware while the PC-1200 uses screw-style mounting hardware.

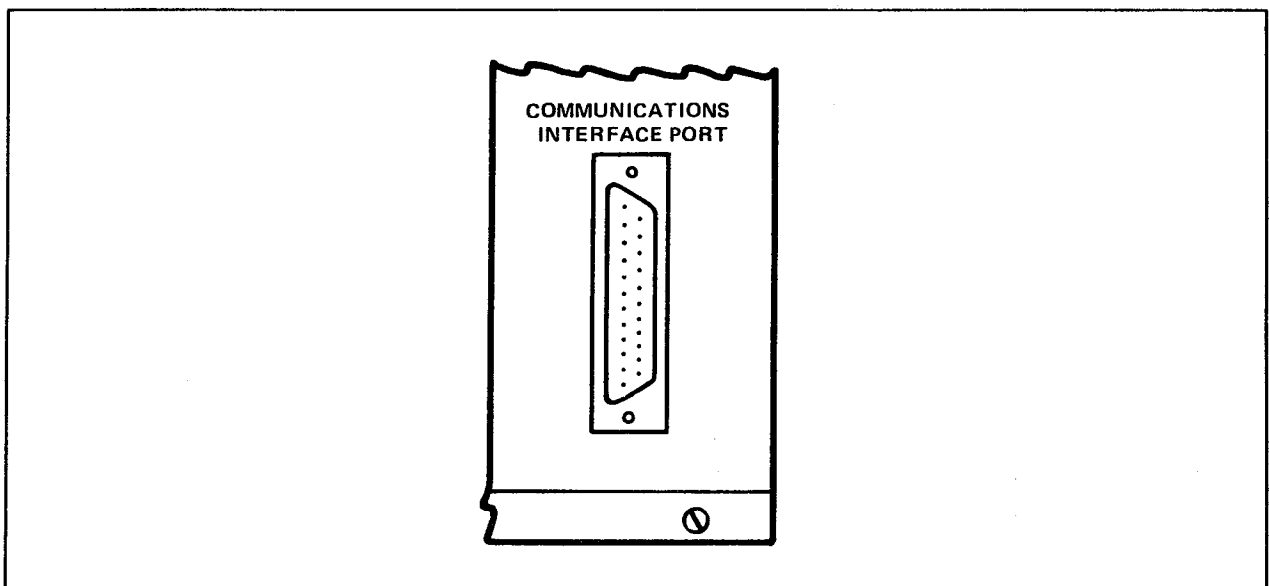

Figure 2-8. Program Loader Port and Computer Port

On the Standard PC-1100, this connector provides a single RS-232 port (Port A), with DIP switch selectable options for baud rate (1200/9600) and parity (odd/none).

On the Advanced PC-1100 and PC-1200, the D-connector incorporates two ports: Port A, which is RS-232, and Port B, which may be RS-232 or RS-485. Both Port A and Port B can be used for program loader or computer communications. Alternately, Port B can support a programmable controller network, as described in Paragraph 3-20 (also see the PT and UA function descriptions in Section 5).

The CP programmable function may be used to change the default (DIP switch selected) baud rate and parity for these ports (see Section 5 for additional details).

Note that although the program loader port (Port A) on the Standard PC-1100 will communicate with RS-232-C compatible devices, it does not meet the related IEEE specification. (For more information, refer to the "Communications Manual," NLAM B-58.) On the Advanced PC-1100 and PC-1200, Port A complies with the RS-232-C standard. For a more detailed description of the serial port, see Paragraph 3-21.

2-10. Specifications and Performance Data

As shown previously in Figure 2-5, the PC-1100/1200 programmable controller incorporates a number of subsections used to store programs, monitor inputs and control outputs. The PC-1100/1200 controller also houses a power supply and a battery backup subsystem. The power supply provides operating power for the controller and its associated input and output modules. The batteries (Type AA alkaline or lithium cells) used for the battery-backup system provide memory retention during loss of power.

Specifications and performance data for these subsections and components of the PC-1100/1200 are given below.

I/O Reference Numbers

The PC-1100 and -1200 system reference number ranges are given in Paragraph 4-6.

Memory Capacity

The PC-1100 programmable controller is available in the following memory sizes:

- 0.5K words RAM
- 1.5K words RAM
- 2.5K words RAM
- 3.5K words RAM

The PC-1200 and PC-1250 programmable controllers are available in the following memory sizes:

- 2K words RAM (PC-1200 only)
- 4K words RAM (PC-1200 only)
- 8K words RAM (PC-1200 or PC-1250)
- 16K words RAM (PC-1200 or PC-1250)

The PC-1100/1200 memory is composed of CMOS RAM with a 16-bit word length.

Programmable Functions

The programmable functions available for PC-1100, Advanced PC-1100, and PC-1200 controllers are described in Section 4 and Section 5.

Scan Rate

The scan rate of the PC-1100/1200 depends upon the amount of memory used and the types of special functions used. In general, the PC-1100 scans discrete contacts at the rate of 7 msec per 1000 contacts; the PC-1200 processes the same contacts at a rate of 0.7 msec per 1000 contacts.

A typical program will include a mix of contacts, coils, and the programmable special functions. The scan rate will be longer when coils and special functions are used; the amount depends on the complexity of the functions used. The PC-1200 is generally four to five times faster than the PC-1100. For example, a sample program (approximately 1K in length) that runs in 20 msec in the PC-1100 will run in 4 to 5 msec in the PC-1200.

Additional information on the programmable functions' scan times can be found in Section 5.

Battery Parameters

For the PC-1100, the following specifications apply:

- Type: 3 Type AA alkaline cells
- Voltage: 1-1/2 volts each: 4-1/2 volts total
- Life: 3 months with power off; 1 year with power on

For the PC-1200, the following specifications apply:

- Type: 1 Type AA lithium cell
- Voltage: 3-1/2 volts total
- Life: 1 year with power off; 5 years with power on (typical)

Environmental Specifications

- Temperature: 0 to 60°C (32 to 140°F)
- Humidity: 0 to 95%, non-condensing through 0 to 60°C (32° to 140°F) range

Input Power

- Standard 120 VAC, 50/60 Hz operation.
(Range: 102 to 132 VAC, 47-63 Hz.)
75 VA maximum (40 VA typical) front-mounted 2 A fuse.
- User-selectable 220 VAC, 50/60 Hz operation.
(Range: 187 to 253 VAC, 47-63 Hz.)
75 VA maximum (40 VA typical) front-mounted 2 A, 3 AG fuse.
- Optional 24 VDC operation (PC-1100 only).
(Range: 21.5 to 28 VDC.)
2 A maximum, front-mounted 3 A, 3 AG fuse.

2-11. 1000 SERIES I/O

The Westinghouse 1000 Series I/O consists of input and output modules, a main I/O rack (which houses the controller and I/O modules), and optional expansion racks and power supplies. These components are described below.

Installation instructions for the 1000 Series modules are given in Section 3. For additional information on the I/O, refer to the applicable Instruction Leaflets.

2-12. Input Modules

All Westinghouse 1000 Series input modules contain circuitry which converts the process signal levels from the input pilot devices into logic voltage levels required by the programmable controller, and provides isolation. Each input module contains conversion circuits mounted on a printed-circuit board. A variety of input modules are available for PC-1100 and -1200 applications. Each provides specific input voltage parameters and formats. Refer to the Instruction Leaflets, shipped as standard with each module, for specifications and detailed descriptions.

Discrete Input Modules: Each input circuit on a discrete input module converts an individual input signal into the voltage level required by the controller's logic. These input signals are typically supplied by pushbuttons, switches, contacts, etc.

There are two basic types of discrete input modules: an 8-point, as shown in Figure 2-9, and a 16-point high density module. (Here, "point" is the equivalent of "input circuit.")

As shown in Figure 2-9, an 8-point module has eight LED indicators which provide visual status of the field voltage at each input. (When lit, the field device voltage is ON.) Because these LEDs are powered by each input circuit, not the PC-1100/1200 controller, the indicators will light even if the controller is stopped or powered-down. A lens on the module's face identifies each LED with respect to its corresponding input circuit.

WARNING

NEVER REMOVE A TERMINAL BLOCK FROM A MODULE WHEN AC LINE POWER IS APPLIED TO THE SYSTEM. DEATH, SERIOUS INJURY, OR IMPROPER EQUIPMENT OPERATION COULD RESULT.

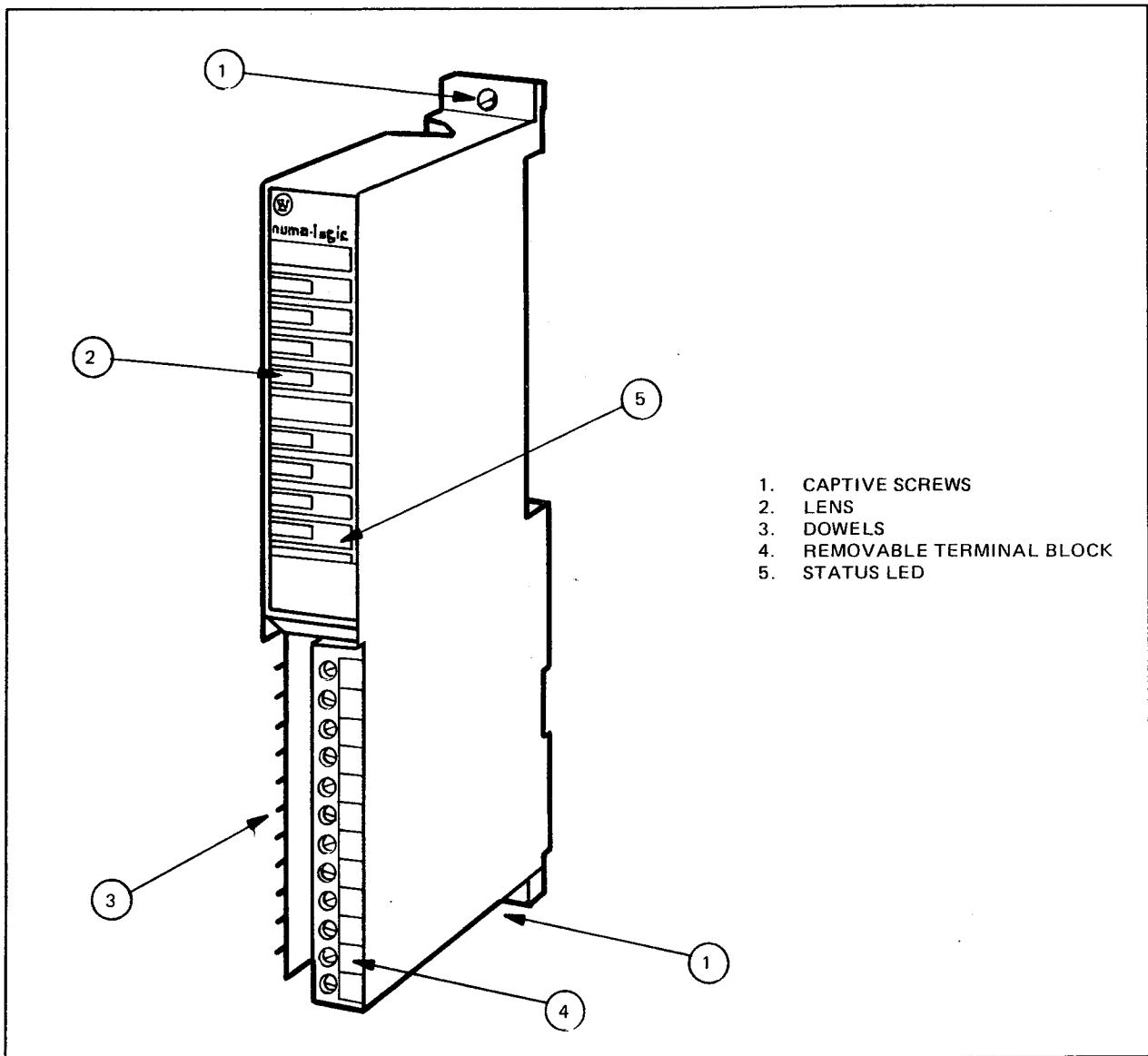

Figure 2-9. Typical Discrete I/O Module

The 8-point modules each incorporate a single 12-position terminal block for field wiring (as shown in Figure 2-10). The 16-point module incorporates two 10-position terminal blocks. The terminal block(s) may be removed, to allow quick module removal from the rack without disrupting the wiring. For ease in wiring, an 8-point module's terminal block can be placed on dowels, as described in Paragraph 2-15.

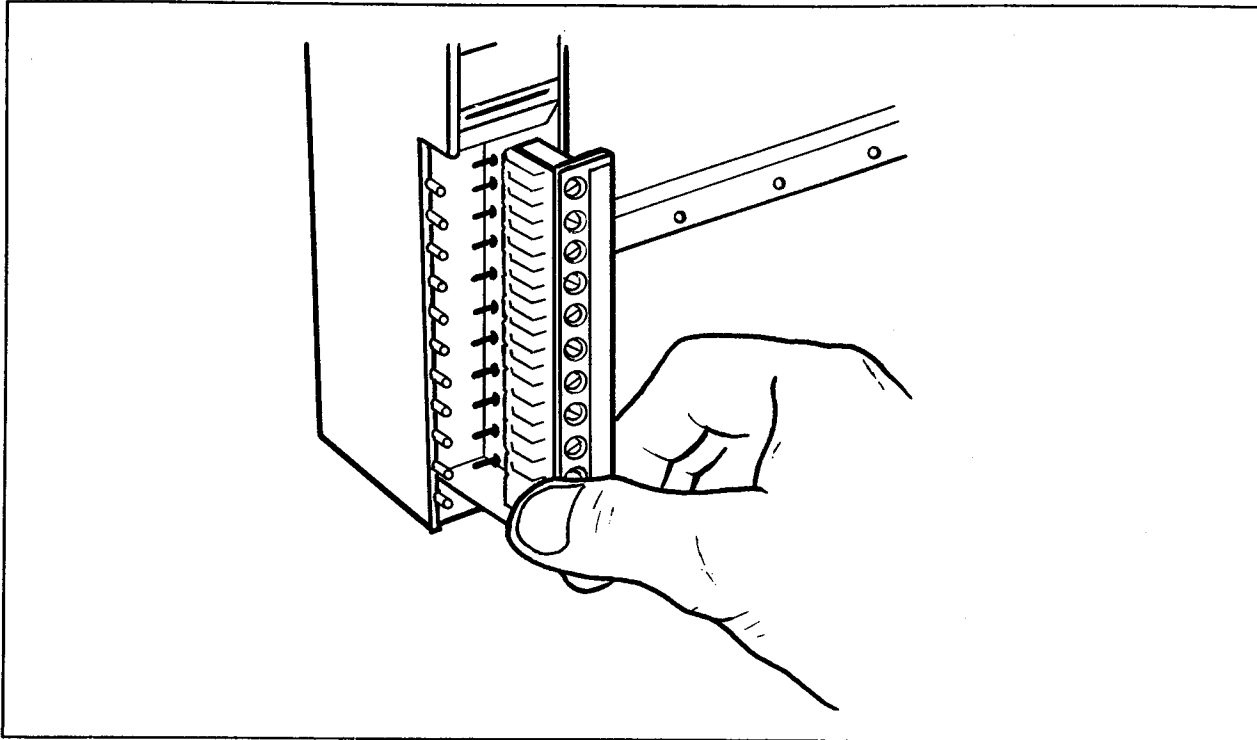

Figure 2-10. Terminal Block Removal

Discrete input modules that may be used with a variety of input signals are available. These are detailed in Table 2-2. Refer to the appropriate Instruction Leaflets for specifications and a detailed description of each discrete input module type.

TABLE 2-2. DISCRETE INPUT MODULES

Catalog No	Circuits	Description
NL-1003	8	12-48 VAC/DC
NL-1005	8	120 VAC/DC
NL-1006	8	240 VAC/DC
NL-1030F	16	24 VDC

Analog Input Modules: Four eight-bit analog input modules are currently available for the PC-1100/1200. Each of the 4 or 8 input circuits on these modules converts an analog input signal (typically supplied by process instrumentation, transducers, etc.) into 8 bits of register information. Two 8-bit inputs are stored per 16-bit register. This approach effectively doubles the possible number of analog input channels when using the 8-bit modules. For additional information on the use of these modules, refer to the Move Byte (MB) special function description. External power is required for these modules (see Paragraph 2-16).

A 12-bit plus sign, 8-channel A/D module is also available. This module provides differential isolated inputs (unipolar or bipolar) with autocalibration. Each channel's input range is individually switch-selectable, and an out-of-range indicator is provided for each channel. Input filtering is also switch-selectable on a per-channel basis.

The signal ranges of the analog input modules are detailed in Table 2-3. Refer to the appropriate Instruction Leaflet for specifications and a detailed description of each analog input module type.

TABLE 2-3. ANALOG INPUT MODULES

Catalog No.	Description
NL-1045	4-Channel, 8-bit A/D converter, 0-5 V
NL-1046	8-Channel, 8-bit A/D converter, 0-5 V
NL-1049	4-Channel, 8-bit A/D converter, 4-20 mA
NL-1050	8-Channel, 8-bit A/D converter, 4-20 mA
NL-1052	8-Channel, 12-bit plus sign A/D converter, Switch-selectable ranges (per channel): +/- 10 V 0-10 V +/- 5 V 0-5 V, 0-20 mA (with 250 Ω resistor) 1-5 V, 4-20 mA (with 250 Ω resistor)

Register Input Module: This module's circuitry converts multi-bit, 3 to 15 VDC TTL compatible input logic signals into the proper controller logic levels and coding. These input logic signals are typically supplied by thumbwheel switches, proximity detectors, word-oriented instruments (i.e. digital voltmeters), etc. The module provides the controller with 16 bits of data during each scan. The register input module is detailed in Table 2-4. Refer to the appropriate Instruction Leaflet for specifications and a detailed description of this module.

Discrete Input Modules Parameters

- Input: See Table 2-2.
- Configuration (8-point modules): 8 circuits, isolated in 2 groups of 4 circuits each. (Note: Isolated groups can be optionally jumpered in common.)
- Configuration (16-point NL-1030F): 16 circuits, isolated in 2 groups of 8 circuits each. (Note: Isolated groups can be optionally jumpered in common.)
- Mounting: Requires 1 I/O rack position.
- Electrical Environment: Surge withstand capability (IEEE 472-1974); NEMA noise immunity (ICS 2-230); provides optical isolation with controller.

TABLE 2-4. REGISTER INPUT MODULE

Catalog No.	Description
NL-1017	3-15 VDC, TTL compatible Register Input Module

Analog Input Modules Parameters

- Inputs: See Table 2-3.
- Configuration: Either 4 or 8 circuits.
- Mounting: Requires 1 I/O rack position.
- Resolution to PC: 8- or 12-bit binary.
- Sampling Rate: 1000 Hz/channel (8-bit) or 640 Hz/channel (12-bit).

Register Input Modules Parameters

- Inputs: 3-15 VDC (TTL compatible).
- Configuration: 1 circuit with 16-bit register input.
- Mounting: Requires 1 I/O rack position.

2-13. Output Modules

All Westinghouse 1000 Series output modules contain circuitry which converts logic levels from the controller into signal levels required to drive output pilot devices. Each output module contains conversion circuits mounted on a printed-circuit board. A variety of output modules are available for PC-1100/1200 applications. Each provides specific output voltage parameters and formats, and provides isolation.

Discrete Output Modules: Each output circuit on a discrete output module converts one of the controller's logic output signals into individual output voltage and current levels required by output devices. Typically, output signals are used to drive motor starters, solenoids, pilot lights, etc.

Like the input modules, each output module type has a lens to identify the LEDs associated with each circuit (see Figure 2-10). For most output modules, the LEDs are powered by the load circuit, and are not driven by the PC-1100/1200 directly. In such cases, the LEDs are dependent on proper load wiring for correct operation. In contrast, other modules, such as the relay outputs, are driven directly by the controller. For additional details, refer to the individual Instruction Leaflets for the modules.

A terminal block is located on the module's face. It may be disconnected to allow for the module's removal from the rack without disrupting the field wiring.

All discrete output modules have individually fused circuits. Some modules also contain blown fuse indicators for each group of 4 outputs. Discrete output modules are available for a variety of output signals. For details, see Table 2-5. Refer to the appropriate Instruction Leaflet for specifications and a detailed description of each discrete output module type.

TABLE 2-5. DISCRETE OUTPUT MODULES

Catalog No.	Description
NL-1015 ¹	Isolated relay output module, NO, 6 point
NL-1016 ¹	Isolated relay output module, NC, 6 point
NL-1080	One form C relay output - Watchdog Module
NL-1020 ²	120 VAC output module, 8 point
NL-1022 ²	24 VAC output module, 8 point
NL-1023 ²	240 VAC output module, 8 point
NL-1025	5 VDC output module (source), 8 point
NL-1026	24 VDC output module (source), 8 point
NL-1027	48 VDC output module (source), 8 point
NL-1060F	24 VDC output module (source), 16 point
¹ The NL-1015 and NL-1016 are Form A and Form B relay output modules, respectively. See Table 2-6 for parameters.	
² AC values given in RMS.	

Analog Output Modules: Each of the four output circuits on the analog output modules provides for digital-to-analog (D/A) conversion. The modules convert programmable controller output logic values into analog output signal levels required by output device operation. Typically, analog output signals are used to provide setpoints for process instrumentation; complete closed-loop control; or speed reference to motor drive systems. Analog output modules are available for four analog output signal ranges, which are detailed in Table 2-6. Refer to the appropriate Instruction Leaflet for specifications and a detailed description of each available analog output module.

Register Output Module: This module's circuitry converts 16-bit register data signals from the controller into multi-bit, 3-15 VDC TTL compatible output logic levels. These output logic levels are typically used to drive readouts. The register output module is detailed in Table 2-7. Refer to the appropriate Instruction Leaflet for specifications and a detailed description of this module.

TABLE 2-6. ANALOG OUTPUT MODULE

Catalog No.	Description	Range*
NL-1057	4 channel, 8-bit D/A converter	0-5V 4-20 mA 0-10 V 0-20 mA
*All the ranges noted here are switch-selectable on the single module.		

TABLE 2-7. REGISTER OUTPUT MODULE

Catalog No.	Description
NL-1018	3-15 VDC, 16-bit register output module (TTL compatible)

Watchdog Module: This module is used to initiate a controlled shutdown of the system or process when a processor or bus line fault is detected. The module contains a fault condition Form C relay output, which de-energizes when a fault is detected, changing the state of the module's outputs.

Discrete Output Modules Parameters

- Output: See Table 2-5 for discrete output module parameters and Table 2-8 for relay output module parameters.
- Configuration (8-point modules): 8 circuits, isolated in 2 groups of 4 circuits each. (Note: Isolated discrete outputs can be optionally jumpered in common.)
- Configuration (16-point NL-1060F): 16 circuits, isolated in 2 groups of 8 circuits each. (Note: Isolated discrete outputs can be optionally jumpered in common.)
- Overcurrent Detection: Type 8AG fuse and fuse-blown LED indicator utilized for each group of 4 circuits (except for NL-1060F; refer to Instruction Leaflet for details).
- Mounting: Requires 1 I/O rack position.
- Electrical Environment: IEEE surge withstand capability, with NEMA noise immunity.

TABLE 2-8. RELAY OUTPUT MODULE PARAMETERS

Parameter	Description
Type	6-circuits, Form A/Form B relay
Mounting	1 I/O rack position
Continuous Current, Max	1.75 A @ 250 VAC 0.25 A @ 125 VAC 1.25 A @ 30 VDC
Peak Current	8 A/10 msec
Working Volts External	12 to 250 VAC 5 to 125 VDC
Power (max)	440 VA 30 watts @ 125 VDC 50 watts @ 30 VDC
Turn-ON time Turn-OFF time	20 msec (nominal) 10 msec (nominal)
Low-Level Switching?	Yes

Analog Output Modules Parameters

- Output: See Table 2-4.
- Configuration: 4 circuits.
- Mounting: Requires 1 I/O rack position.
- Resolution: 8-bit binary.

Register Output Modules Parameters

- Output: 3-15 VDC (TTL compatible).
- Configuration: 16-bit register output.
- Mounting: Requires 1 I/O rack position.

2-14. I/O Racks

The 1000 Series I/O modules and PC-1100/1200 controller are mounted in a standard 1000 Series horizontal rack. Several "main" racks (which house the controller plus I/O modules) are available, as well as several "expansion" racks (which house additional I/O modules only). The following main and expansion racks are available:

- NLR-1004 (for controller plus up to 4 I/O modules)
- NLR-1008 (for controller plus up to 8 I/O modules)
- NLR-1012 (for controller plus up to 12 I/O modules)
- NLR-1016 (for controller plus up to 16 I/O modules)
- NLRE-1009 (for up to 9 I/O modules)
- NLRE-1011 (for up to 9 I/O modules, with "G select" strap)
- NLRE-1011B (for up to 9 I/O modules, with "G select" switch and rack-mounted power supply)
- NLRE-1013 (for up to 13 I/O modules)
- NLRE-1017 (for up to 17 I/O modules)

Installing the controller and I/O modules in the rack is a simple process (see Paragraph 3-15). Simply align the units's edge pins with the rack's backplane edge connectors. Then gently press them into place. Use a screwdriver to tighten the captive screws on the controller and modules to the threaded holes on the rack. No other electrical connections are needed between the controller and I/O modules.

Note that for eight-point discrete I/O modules, addressing is dependent on rack position, group (or G select), and I/O bus (dual I/O bus available for PC-1250 only). By contrast, analog, register, and 16-point discrete I/O referencing is determined by switches located on the modules. When using the discrete 8-point modules, some attention must be given to their rack position and addressing. This is discussed in more detail in Paragraph 3-15.

Expansion Rack Configurations

The Rack Bus Expander (RBE) module (NL-1076 or -1077) is used to repeat signals between two racks. When using any expansion rack, one position on the primary rack must be used for the RBE module. An RBE module is also used to connect one expansion rack to another.

Note that each expansion rack contains an odd number of slots. The "extra" slot in the expansion rack effectively replaces the main rack slot used by the RBE module. For example, if a nine-slot NLRE-1009 is added to an eight-slot NLR-1008, one slot (in the main rack) will be used for the RBE and 16 will be available for I/O modules (7 in the main rack and 9 in the expansion rack).

To access the PC-1250's dual I/O bus, the NL-1077 must be used. In the PC-1250, half of the available I/O addresses are accessed through the "Low" bus (discrete addresses 1-128, registers 1-64, or groups 1-8), and the other half are accessed through the "High" bus (discrete addresses 129-256, registers 65-128, or groups 9-16). The Low bus is equivalent to the single bus available on the PC-1200-1041, -1042, and -1043.

While the NL-1076 incorporates a single "D" connector for one rack expansion cable, the NL-1077 incorporates two "D" connectors. A toggle switch on the back of the NL-1077 allows the High bus signals to be sent between the main rack and other racks. When the toggle switch is set to LOW, both connectors will transmit the Low bus. When the toggle switch is set to HIGH, the top connector will transmit the High bus (the bottom connector will always transmit the Low bus) .

Caution

Do not mix NL-1076 and NL-1077 modules within a system.

Table 2-9 shows the recommended combinations of controllers, expansion racks, and RBE modules.

The rack expansion cable (NLC-1074(B) or NLC-1077) runs from the RBE module to the D connector on the left side of the expansion rack. Note that the NLC-1074(B) cable (used with the NL-1076) is 3 ft in length, while the NLC-1077 cable (used with the NL-1077) is available in 2, 3, 4, and 6 ft lengths.

The NL-1077 also provides a fault signal for the expansion power supply (NLE-1070). Some models of the PC-1100 do not recognize this signal (see Table 2-9).

TABLE 2-9. CONTROLLER, EXPANSION RACKS, AND RBE COMBINATIONS

Controller	Racks	RBE module(s)
PC-1100	NLRE-1009	NL-1076
	NLRE-1011 ¹	NL-1076
	NLRE-1011B ¹	NL-1077 ²
PC-1200 or PC-1250	NLRE-1009 ³	NL-1076 ⁴
	NLRE-1011	NL-1076 ⁴
	NLRE-1011B	NL-1077 ²
	NLRE-1013	NL-1077 ²
	NLRE-1017	NL-1077 ²

¹ G select 2 (on the NLRE-1011/1011B) is not valid with the PC-1100.

² "High bus" selection on the NL-1077 is only valid with the PC-1250.

Also, PC-1100 models prior to the PC-1100-1052/1054/2052/2054 cannot read the remote power supply failure fault line.

³ G select 2 not available on the NLRE-1009.

⁴ NL-1076 cannot access the PC-1250 dual I/O bus.

Typically, the first I/O module position on the primary rack is used for the RBE, as shown in Figure 2-11. As noted previously, each expansion rack has an "extra" slot which effectively replaces the main rack slot used by the RBE module. Thus, the nine-slot expansion racks (NLRE-1009/1011/1011B) add eight modules to the system total. Similarly, the 13-slot expansion rack (NLRE-1013) provides an additional twelve modules, and the 17-slot expansion rack (NLRE-1017) provides an additional 16 modules.

Other examples of system configurations using expansion rack(s) are shown in Figures 2-12 through 2-17. Note that the PC-1200 may use any of the expansion racks (the PC-1100 normally uses only the NLRE-1009).

The "star" configuration shown in Figure 2-12 is applicable to both the PC-1100 and the PC-1200; however, the "daisy chain" configuration shown in Figure 2-13 is not valid for the PC-1100. The examples shown in Figures 2-14 through 2-17 apply to the PC-1200.

Paragraph 3-15 discusses addressing considerations when using the expansion racks. For additional information on the expansion racks and RBE modules, refer to the applicable Instruction Leaflet.

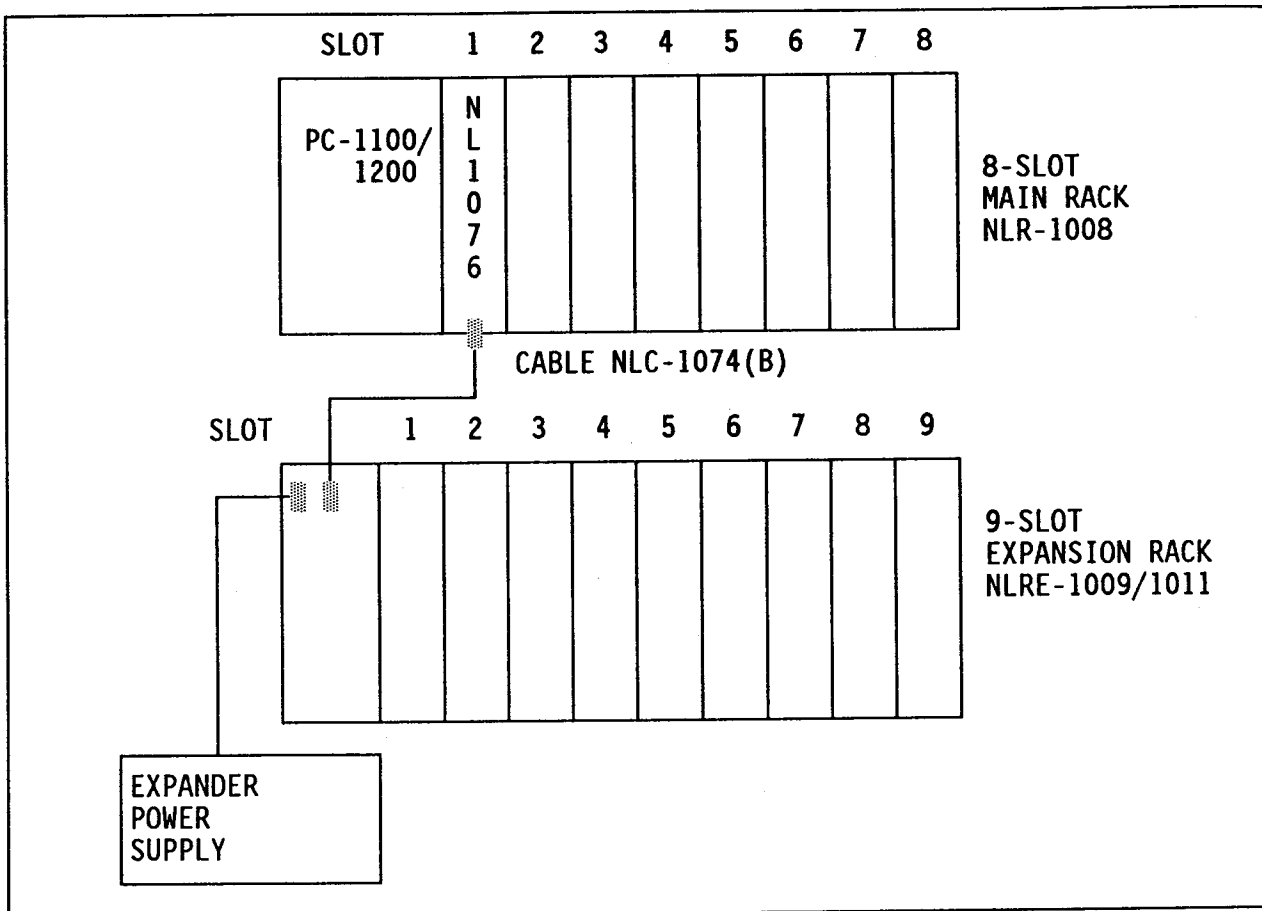
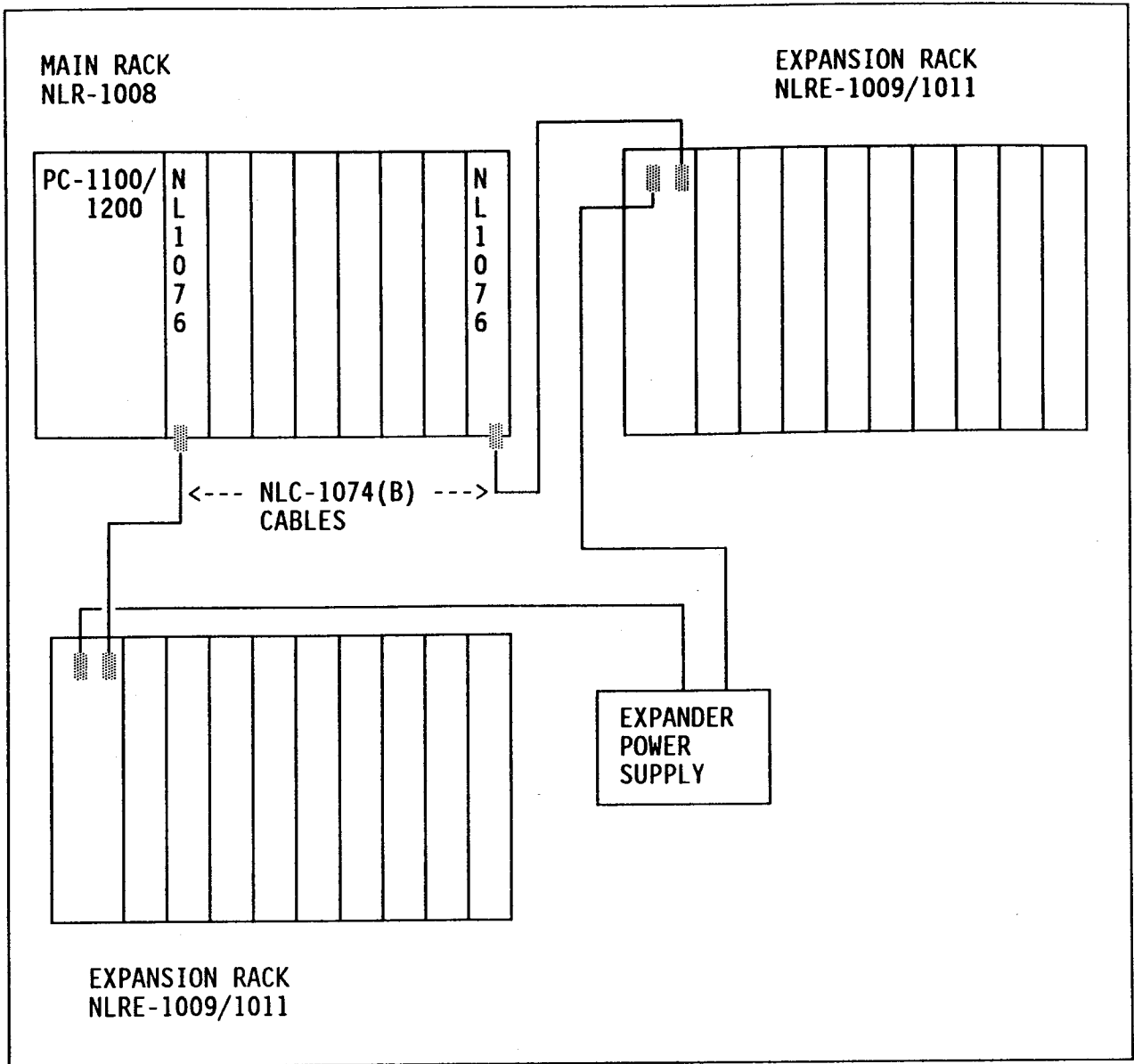
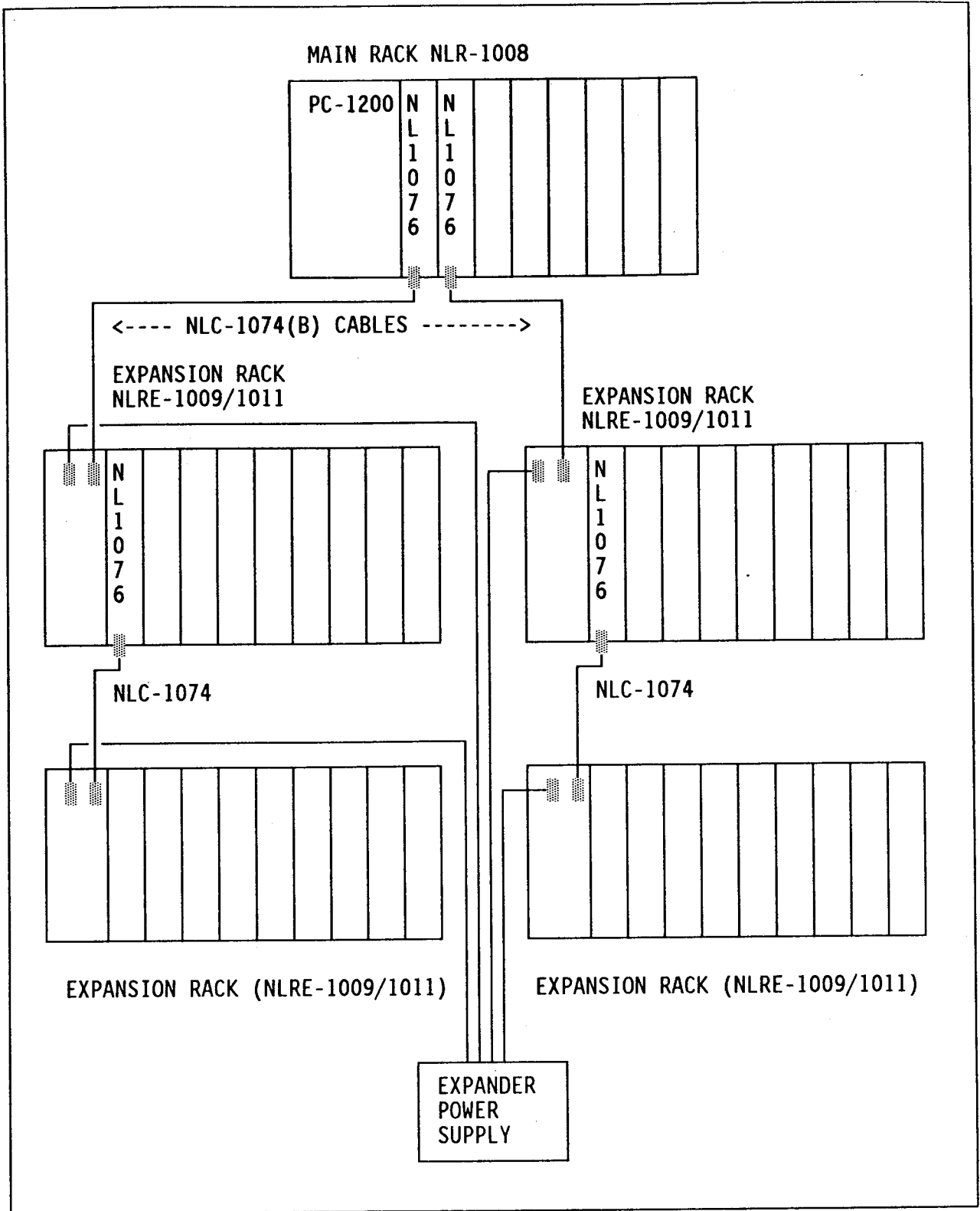

Figure 2-11. Example PC-1100/1200 System Configuration (Using NLR-1008, NL-1076, and NLRE-1009/1011)



**Figure 2-12. Example PC-1100/1200 Configuration
(Using NLR-1008, Two NL-1076s, and Two NLRE-1009/1011s)**



**Figure 2-13. Example PC-1200 Configuration
(Using NLR-1008, Four NL-1076s, and Four NLRE-1009/1011s)**

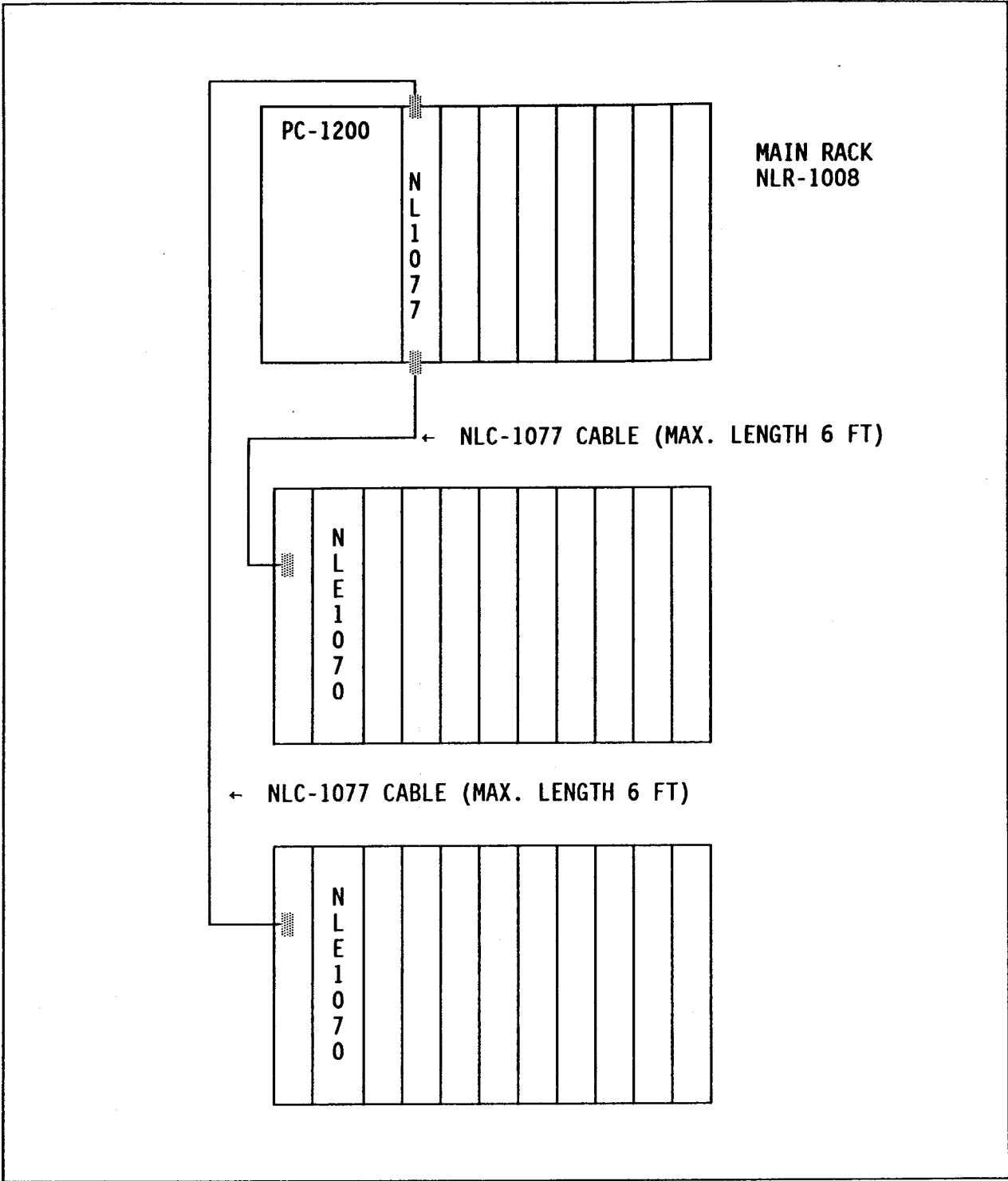

**Figure 2-14. Example PC-1200 Configuration
(Using NLR-1008, NL-1077, and Two NLRE-1011Bs)**

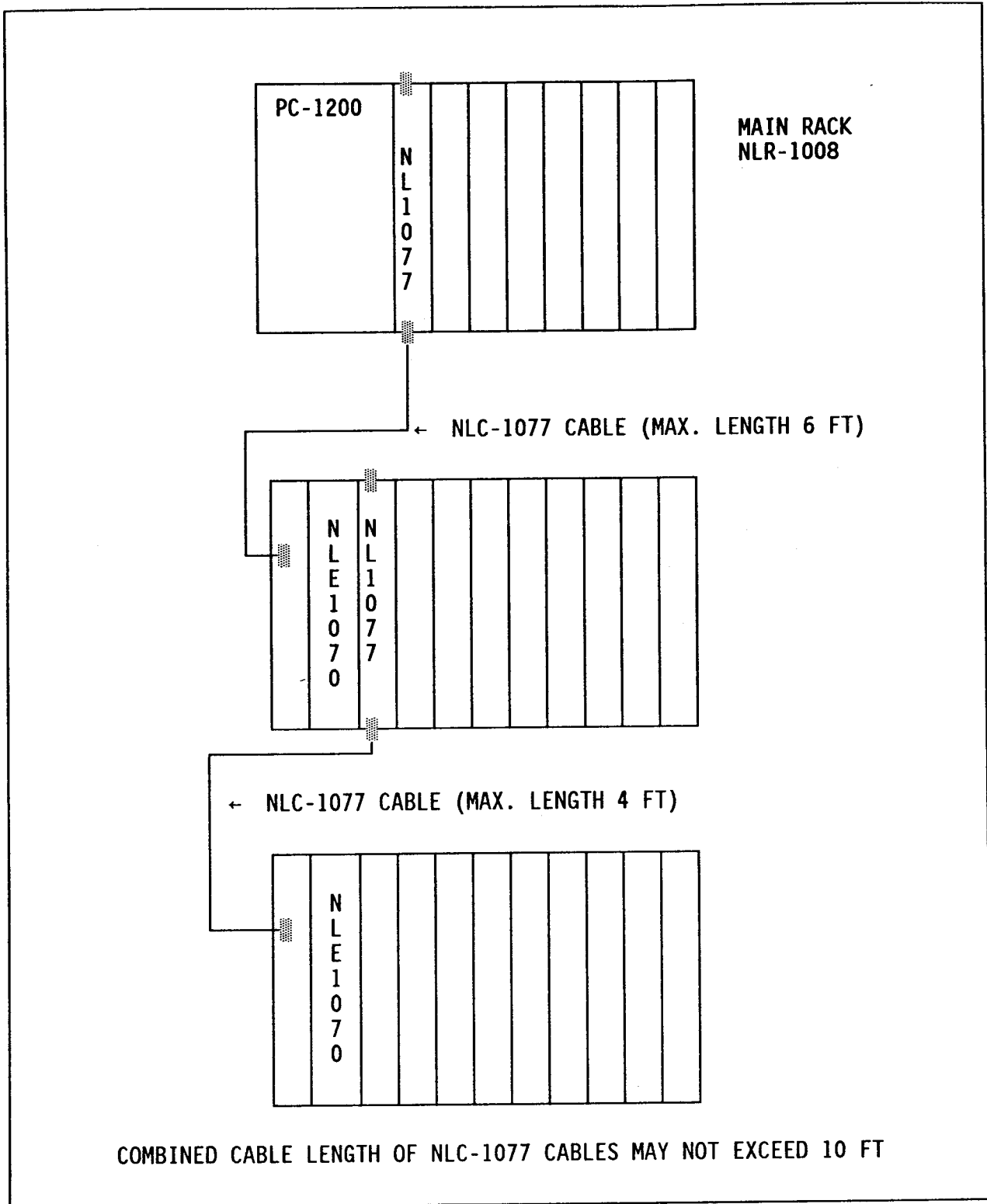

**Figure 2-15. Example PC-1200 Configuration
(Using NLR-1008, Two NL-1077s, and Two NLRE-1011Bs)**

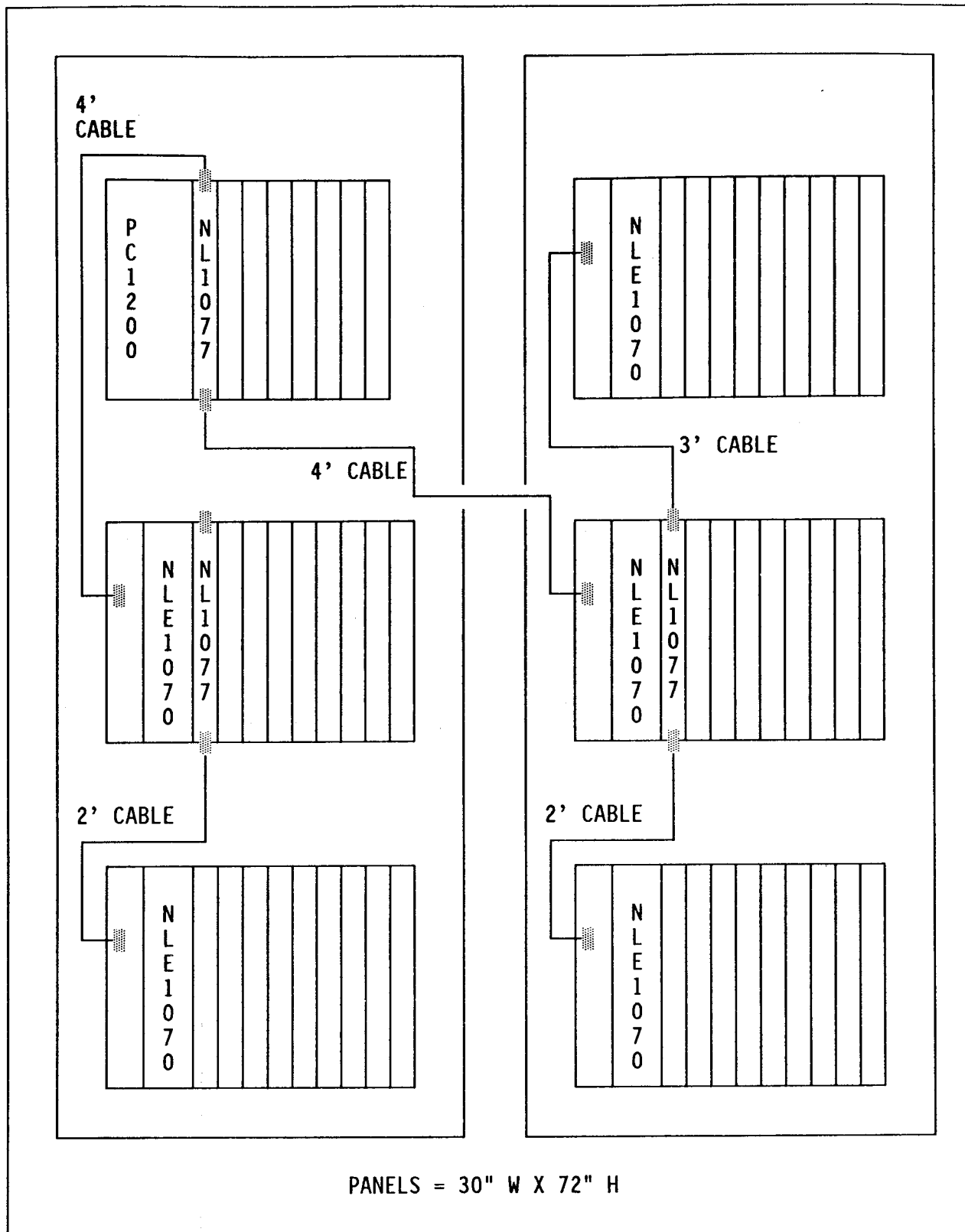
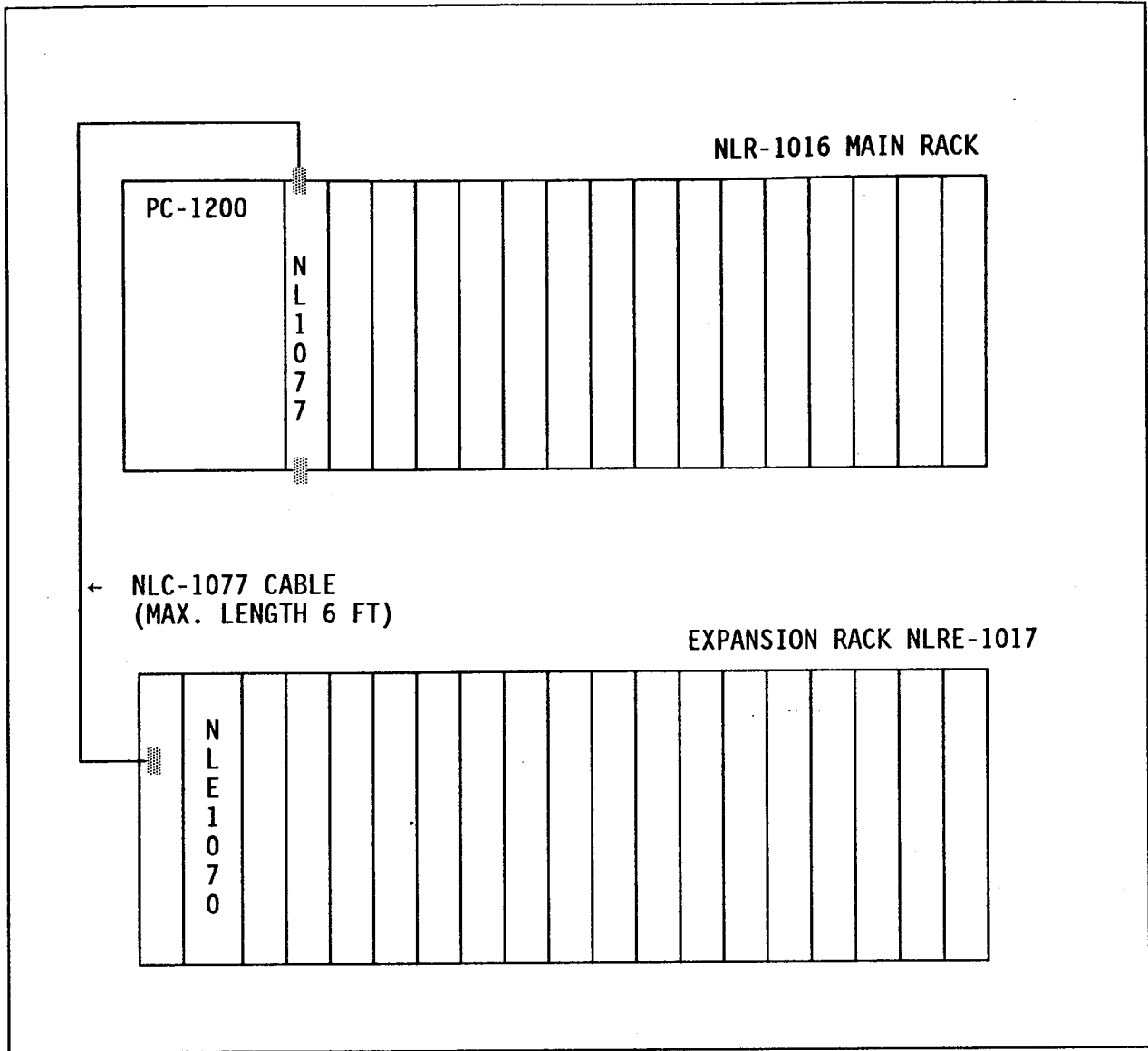

Figure 2-16. Example PC-1200 Configuration
 (Using NLR-1008, Three NL-1077s, and Five NLRE-1011Bs)



**Figure 2-17. Example PC-1200 Configuration
(Using NLR-1016, NL-1077, and NLRE-1017)**

2-15. Field Wiring

Field wiring to the system is accomplished through the removable terminals blocks located on the modules. (See Figures 2-9 and 2-10.) The 8-point modules incorporate dowels designed to hold the terminal block in an extended position. Grooves in the terminal block mate with these dowels to provide a temporary "third hand", for easier initial wiring.

Note

The 16-point 24 VDC modules (NL-1030F and NL-1060F) use two 10-position removable (Phoenix-style) terminal blocks, which do not use the dowel holders. For additional details, refer to the applicable Instruction Leaflet.

After wiring, the terminal block should be returned to its normal position with the power off. For additional information on field wiring, see Paragraph 3-16.

2-16. I/O Power Requirements

The power consumption of the I/O cards within each rack must not exceed the supply for that rack. Table 2-10 states the power requirements for the 1000 Series I/O modules. (For additional information on the modules, refer to the applicable Instruction Leaflets.)

I/O power may be provided by the controller's internal power supply or an expansion power supply. In general, the I/O cards in the main rack are powered by the internal supply, while the I/O cards in the expansion rack(s) are powered by an expansion supply, as described below.

Integral Power Supply

The controller's integral power supply supports the DC power requirements of the controller and the main rack I/O modules. Although power can be bussed to one NLRE-1009 expansion rack, the quantity is significantly limited.

- The Standard PC-1100 integral power supply is capable of providing 2 A to the main rack I/O modules (or 1.5 to the main rack and 0.3 to the NLRE-1009 expansion rack).
- The Advanced PC-1100 integral power supply is capable of providing 1.7 A to the main rack I/O modules (or 1.2 to the main rack and 0.3 to the NLRE-1009 expansion rack).
- The PC-1200 integral power supply is capable of providing 2.5 A to the main rack I/O modules (or 1.2 A to the main rack and 0.3 A to the NLRE-1009 expansion rack).

Additional power may be provided to the expansion rack(s) by using an expansion power supply, as described below.

TABLE 2-10. 1000 SERIES MODULE POWER REQUIREMENTS

Module Catalog Number	Power Required from Controller	External Power Supplies Needed
NL-1003	10 mA	--
NL-1005	10 mA	--
NL-1006	10 mA	--
NL-1015	10 mA, plus 80 mA per circuit ON	--
NL-1016	10 mA, plus 80 mA per circuit ON	--
NL-1017	100 mA	4.8-15.0 Vdc @ 100 mA
NL-1018	100 mA	4.5-6.0 Vdc @ 500 mA, 4.5-24.0 Vdc @ 125 mA
NL-1020	10 mA, plus 25 mA (typical) per circuit ON	--
NL-1022	10 mA, plus 25 mA (typical) per circuit ON	--
NL-1023	10 mA, plus 25 mA (typical) per circuit ON	--
NL-1025	10 mA, plus 25 mA (typical) per circuit ON	--
NL-1026	10 mA, plus 25 mA (typical) per circuit ON	--
NL-1027	10 mA, plus 25 mA (typical) per circuit ON	--
NL-1030F	30 mA	--
NL-1045	100 mA	*9-15 VDC @ 100 mA
NL-1046	100 mA	*9-15 VDC @ 100 mA
NL-1049	100 mA	*9-15 VDC @ 100 mA
NL-1050	100 mA	*9-15 VDC @ 100 mA
NL-1052	200 mA	--
NL-1057	180 mA	15-24 VDC
NL-1060F	10 mA plus 25 mA (typical) per circuit ON	--
NLMZ-1799	350 mA	5.0 VDC @ 500 mA

*The NLPS-500 (12 VDC, 0.8A) power supply is recommended for these modules.

Expansion Power Supply

An expansion power supply may be optional or required, depending on the expansion rack(s) used and the system configuration:

- For a single NLRE-1009, an external expansion power supply may be used to provide a greater amount of power than can be bussed from the main rack.
- When multiple NLRE-1009 expansion racks are used, external power must be provided.
- For the NLRE-1011, an external expansion power supply is always required.
- For the NLRE-1011B, -1013, and -1017, the rack-mounted NLE-1070 expansion power supply is required.

Note that power can only be bussed from the main rack to the NLRE-1009, not to any other expansion rack. Also note that power cannot be bussed between expansion racks. Thus, except for a single NLRE-1009, all expansion racks must have a dedicated expansion power supply.

Table 2-11 shows the characteristics of the NLE-1070 expansion power supply. A user-supplied external expansion power supply should conform to these specifications.

TABLE 2-11. NLE-1070 EXPANSION POWER SUPPLY CHARACTERISTICS

Parameters	NLE-1070 Specifications	Notes (External Power Supply) ¹
Input Voltages	95 - 132 VAC 47-63 Hz or 190 - 260 VAC 47-63 Hz	Voltage range is selectable on the NLE-1070; on external supply, dual range for convenience only.
Output Voltage	5.075 VDC +/- 10 mV	5.0 VDC
Output Current	0 AMP Min./5 AMPS Max.	Available output current must be greater than the maximum I/O draw plus 20%.
Load Regulation	0.5% Max.	Total regulation must be better than 1.0%.
Line Regulation	0.1% Max.	
Overvoltage Protection	6.20 VDC +/- 0.6 VDC	Must prevent voltage from exceeding 6.80 V (worst case).
Line isolation	Provided	Recommended ²
Current limiting	Provided	Recommended
IEEE Surge Noise Immunity	Meets IEEE-472-1974	Recommended ²
<p>¹ Use these notes to determine requirements for user-supplied external power supply. For additional information, refer to the applicable Instruction Leaflet or contact your Westinghouse representative.</p> <p>² The isolation of this power supply will determine the system isolation.</p>		

Note

When the NL-1077 Rack Bus Expansion module is used, the expansion power supply is monitored, and power failure is reported to the controller.

2-17. PERIPHERAL EQUIPMENT

To facilitate system programming, documentation and operator control of the PC-1100/1200, a wide selection of peripheral equipment is available. The selection of peripheral devices is dependent on specific user applications.

Generally, the preferred programming device is the Advanced Program Loader, which is an IBM-compatible personal computer using Westinghouse software (NLSW-781 to -784). However, a number of other devices are available.

A brief description of the available peripherals follows.

2-18. Advanced Program Loader

The Advanced Program Loader (APL) is an IBM-compatible personal computer (such as an IBM-PC, IBM-XT, or COMPAQ) with the Westinghouse APL software. While any fully IBM-compatible unit (with MS-DOS and the same BIOS as IBM) may be used, only the IBM and COMPAQ units listed below have been tested by Westinghouse:

- IBM Portable Computer (NLPL-1581)
- COMPAQ Portable Computer (NLPL-1580)
- Industrially hardened IBM 5531 (NLPL-1582)
- Industrially hardened IBM 7531 (NLPL-1584)
- Industrially hardened IBM 7532 (NLPL-1584)

These units may be ordered from Westinghouse using the catalog numbers shown above.

The APL software is available on 5-1/4 or 3-1/2 in. diskettes. The available versions of the APL software are listed below:

- APL Programming Package (NLSW-783)
- APL Programming and Offline Utilities Package (NLSW-783U)
- Integrated APL Programming/Documentation/Utilities Package (NLSW-784)

Note that earlier versions of the APL software (NLSW-781 and -782) required the use of an AST CC-232 interface card. For the version listed above (NLSW-783, -783U, and -784), the CC-232 is not required (COM 1/2 may be used).

For additional information on the APL and these software packages, refer to "Advanced Program Loader Programming Manual" (NLAM-B816) or contact your Westinghouse representative.

2-19. CRT Program Loader

The NLPL-780 CRT program loader is an alternative user interface for the PC-1100/1200 programmable controller system. As shown in Figure 2-18, the CRT program loader consists of a CRT display, keyboard and a convenient cable storage compartment.

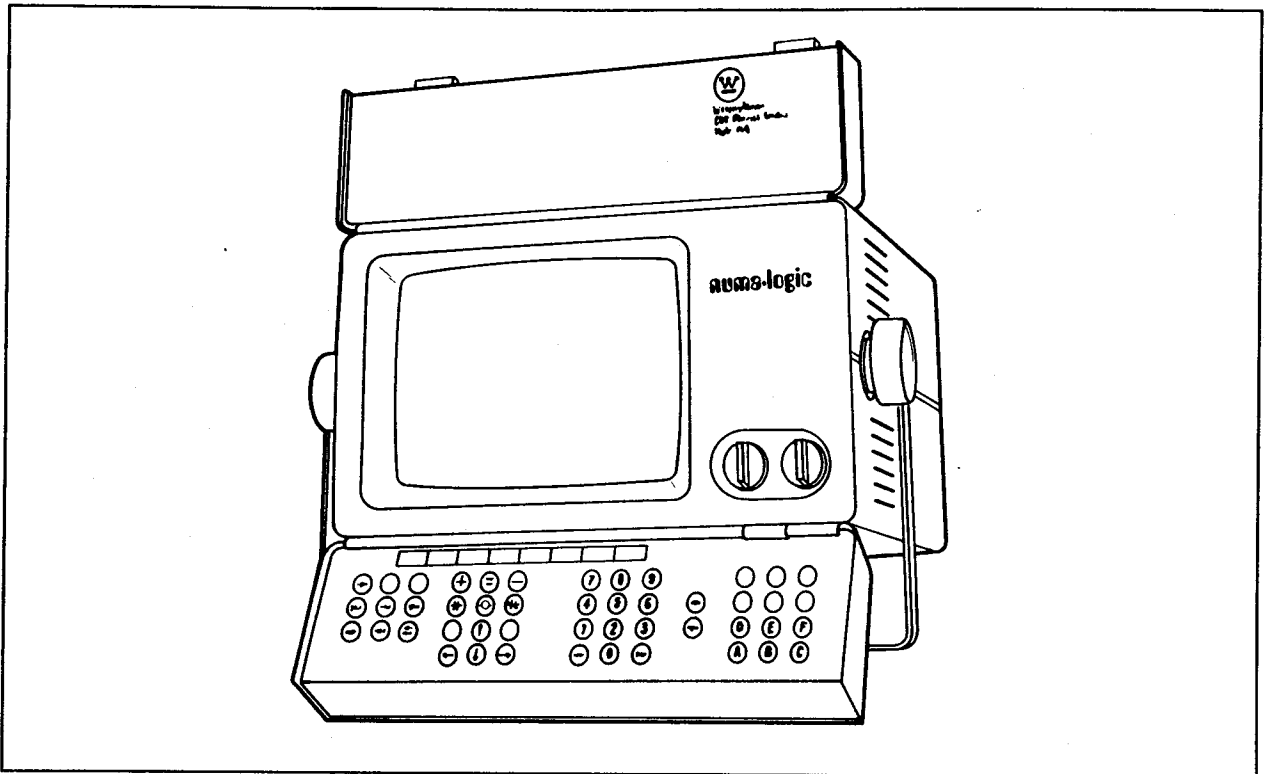

Figure 2-18. CRT Program Loader

The CRT program loader is compatible with the NLTL-783 tape loader (described in Paragraph 2-22 below). For additional information on the CRT program loader, refer to "CRT Programming Manual" (NLAM-B56).

2-20. Mini Loader

The NLPL-789 mini loader is shown in Figure 2-19. The mini loader is a hand-held program loader. As shown in Figure 2-19, the mini loader is a compact unit which contains a 35-key keyboard, LCD screen display and an integral communications cable.

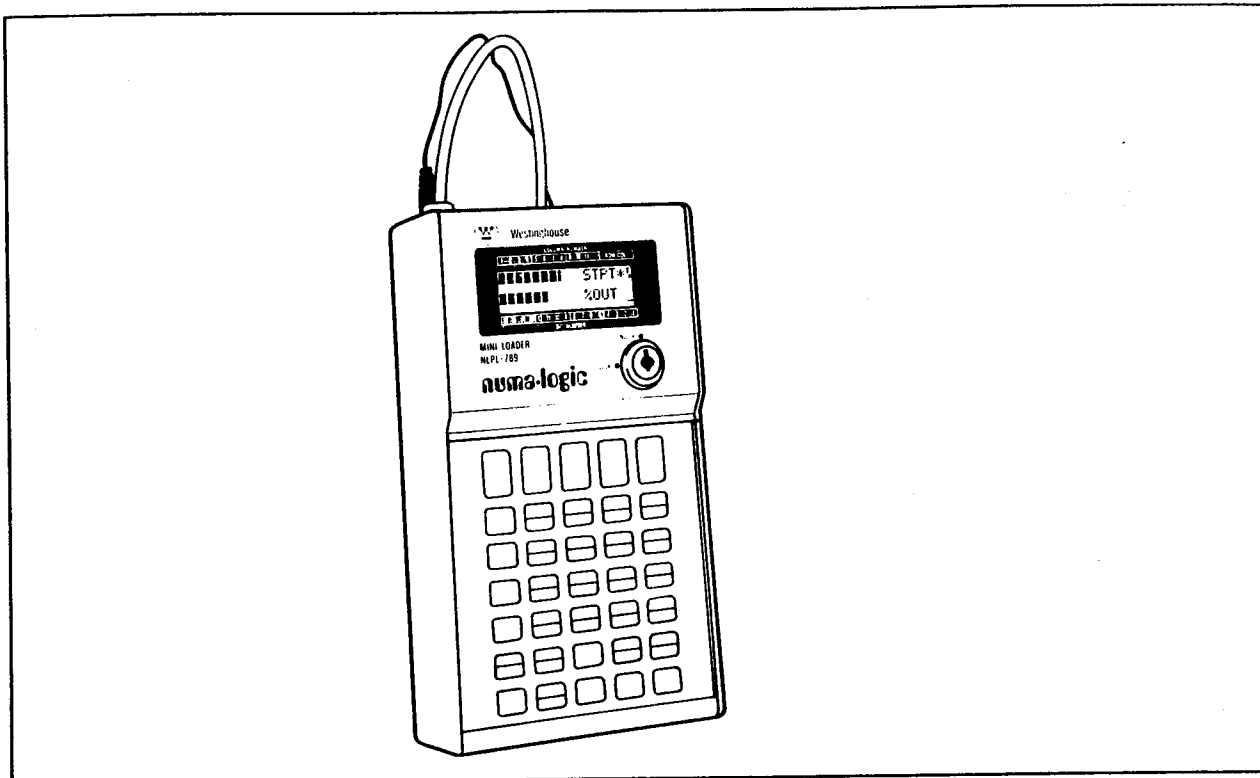

Figure 2-19. Mini Loader

The mini loader is available with a tape mode capability. The optional mini loader tape mode permits the user to record, load or verify ladder diagrams from a standard audio cassette used for program storage.

For greater detail on the mini loader and its usage, refer to "Mini Loader Programming Manual" (NLAM-B60).

2-21. Printer

A printer can be connected to the program loader and used to print the user's relay ladder diagram, complete with line numbers and cross references. Also, the controller's I/O status and register contents can be printed. For PC-1100/1200's with ASCII Transmit capability, the printer can be used to print reports or alarm messages directly from the controller's serial ports. When using the Advanced Program Loader (IMB-compatible personal computer), either the parallel or serial communications port (LPT 1/2 or COM 1/2) can be used for these print functions.

Westinghouse offers a Centronics line printer (NLP-786), which has the following features:

- Asynchronous RS-232 interface
- 96-character ASCII compatibility
- 40/80/132 column format

Users may select other printers with these features (132 column format is not required). Directions for the operation of the NLP-786 printer are given in the "CRT Programming Manual" (NLAM-B56).

2-22. Tape Loader

The NLTL-783 tape loader provides program storage on digital cassettes for PC-1100/1200 systems.

The tape loader works in conjunction with the CRT program loader to store programs on digital cassette tapes or to load programs into the controller from tapes. This device provides permanent storage of reference ladder diagrams. The tape loader also verifies the controller's memory contents against stored data on tapes. Directions for the use of the tape loader are given in the "CRT Programming Manual" (NLAM-B56).

2-23. Memory Safe™ Program Cartridge (PC-1100)

The Memory Safe Program Cartridge is a means to store and load ladder programs and registers. It may be attached to the controller and used as nonvolatile memory, thereby eliminating the need for battery-backed RAM in the controller. (See Figure 2-20.) It may also be used as a portable means to store user software (similar to a cassette tape). The final, total capacity of the controller system is limited to the capacity of the controller itself or the capacity of the chosen Memory Safe cartridge, whichever is smaller. The available memory sizes of the program cartridge are given below:

- 385 words of ladder diagram and static registers, 63 dynamic (nonvolatile) registers, and 64 volatile dynamic registers (Total: 512 words).
- 1409 words of ladder diagram and static registers, and 127 dynamic (nonvolatile) registers (Total: 1.5K words).
- 3457 words of ladder diagram and static registers, and 127 dynamic (nonvolatile) registers (Total: 3.5K words).

Note that the Memory Safe Program Cartridge models NLMS-1100 A, B, and C are used only with the PC-1100.

Note

If the Memory Safe unit is to be used in place of battery-backed RAM, only off-line programming should be used. Set the OLP switch as described in Paragraph 3-17 to disable the on-line programming capability.

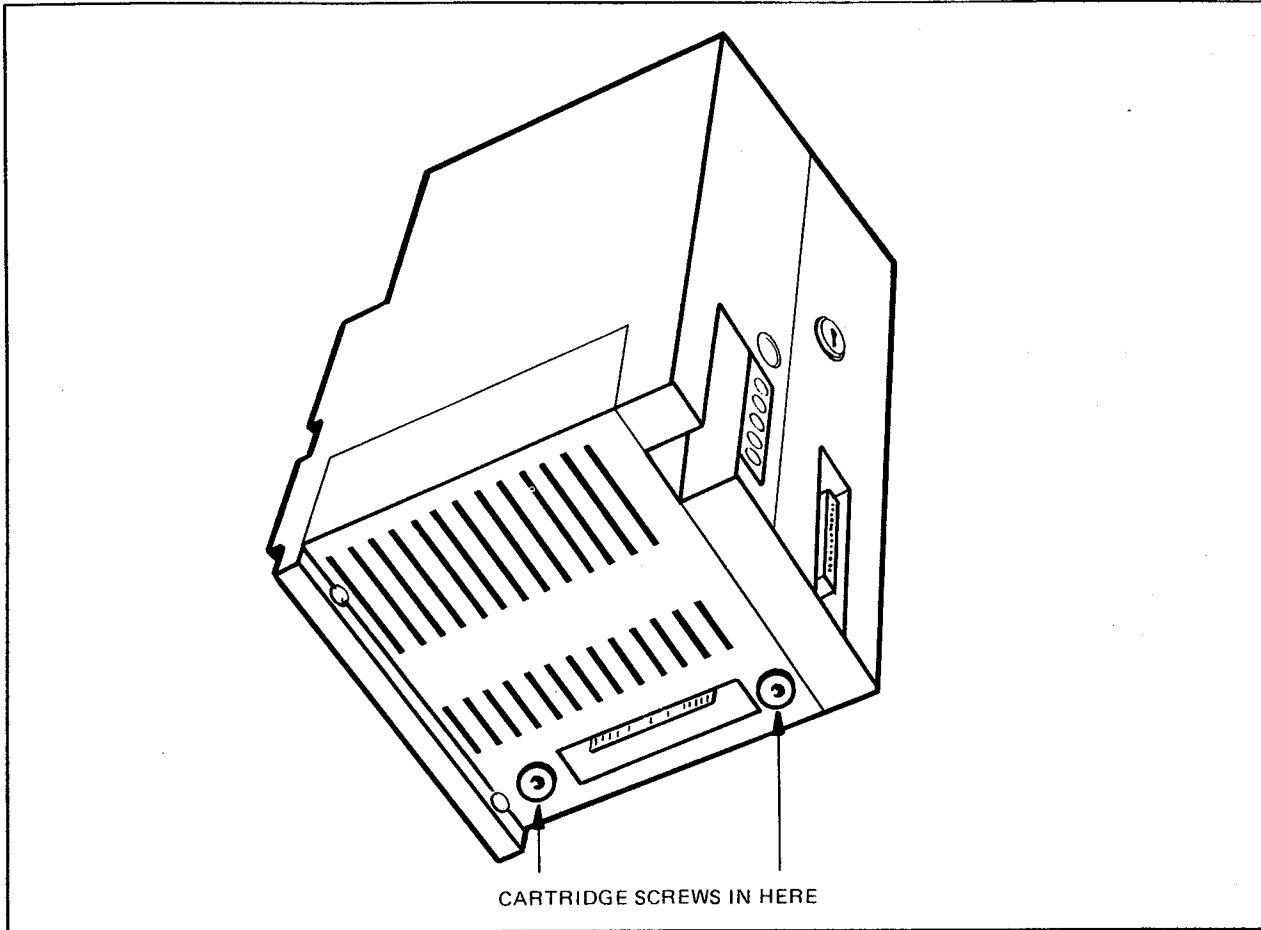

Figure 2-20. Attaching Memory Safe Cartridge to Controller

The program cartridge memory consists of electrically erasable PROMs (EEPROMs) which are used to store the ladder program and static registers. It also incorporates a NOVRAM™ which is used to store the 63 (or 127) nonvolatile, dynamic registers upon power-down of the controller.

Nonvolatile dynamic registers are the first 63 (or 127) holding registers of the controller. Their contents may change during normal system operation, yet their values must be maintained during a power-down. (Production counters are an example of this.) Their current values will be transferred to (and stored by) the Memory Safe cartridge upon power-down of the controller. Static registers are the remaining registers of the controller. Their contents do not change during normal system operation. (Timer presets are an example of this.) Thus, there is no need to transfer the contents to the program cartridge on power-down.

If the user needs more than 127 dynamic retentive registers, a controller with battery-backed RAM must be used. Dynamic volatile registers are generally used for intermediate math results and non-retentive timer/counter actuals.

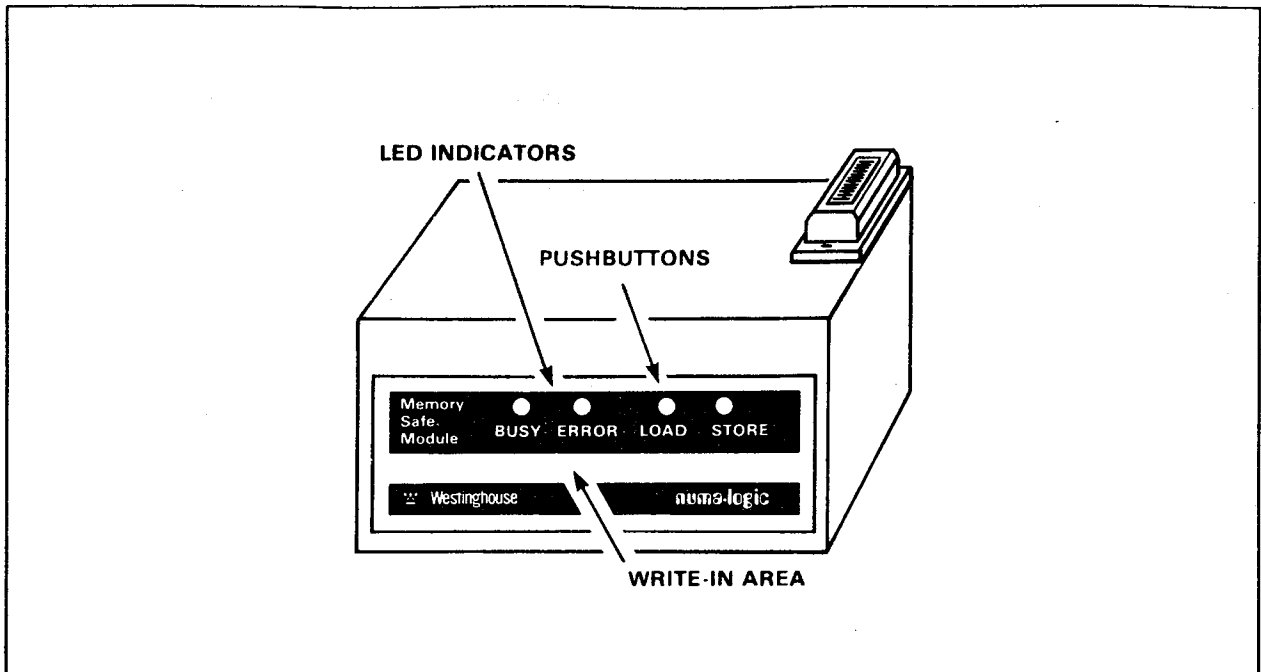

Figure 2-21. Memory Safe Program Cartridge

A Memory Safe program cartridge is shown in Figure 2-21. The two pushbutton switches mounted on the front are the LOAD and STORE switches. When pressed, the STORE button causes the controller to store the contents of its user memory in the cartridge's EEPROM memory. The LOAD button causes the controller to load the contents of the program cartridge into the controller's user memory. (The store and load functions are only enabled when the controller is in STOP mode.)

If the cartridge is mounted to the controller and the keyswitch is in the RUN position, the load function will automatically be executed upon power-up of the processor.

The two LEDs shown in Figure 2-21 are the BUSY and ERROR indicators. When ON, BUSY indicates that a cartridge function, such as load or store, is being performed. When the function is complete, the BUSY LED will extinguish. The ERROR LED is energized when a load or store function is not completed. This could be due to a checksum error, etc. If the ERROR LED is energized, repeat the operation. If the condition persists, remove and replace the cartridge.

The Memory Safe cartridge can also be used to prohibit changes in reference ladder software.

For more detailed information on the Memory Safe program cartridge, refer to the applicable Instruction Leaflet (IL-15694).

2-24. Peripheral Compatibility

When selecting peripherals, several facts must be considered to ensure user needs are satisfied:

- The NLTL-783 tape loader is used with either the NLPL-780 or NLPL-780P CRT program loader.
- The NLP-786 printer can be used with the APL or with the NLPL-780P CRT program loader with print option.
- The NLPL-789 mini loader is not used with the NLTL-783 tape loader or the NLP-786 printer.
- The NLPL-789 mini loader with tape capability option can use a standard audio cassette recorder/player.
- The NLPL-780P CRT program loader can use other RS-232-C compatible printers operating at 110, 300, 600, 1200, 2400, 4800 or 9600 baud. However, internal printer modification may be required.
- The PC-1100/1200 controller's program loader port can be used as an RS-232-C interface with a computer, when suitable handshaking software is present in the computer.
- The batteries used to retain RAM memory during a power outage may be removed if the Memory Safe program cartridge is used as a full-time back-up unit. In addition, the OLP DIP switch should be set for off-line programming (see Paragraph 3-17).